

97/AUTO SCOPEMETER

USERS MANUAL

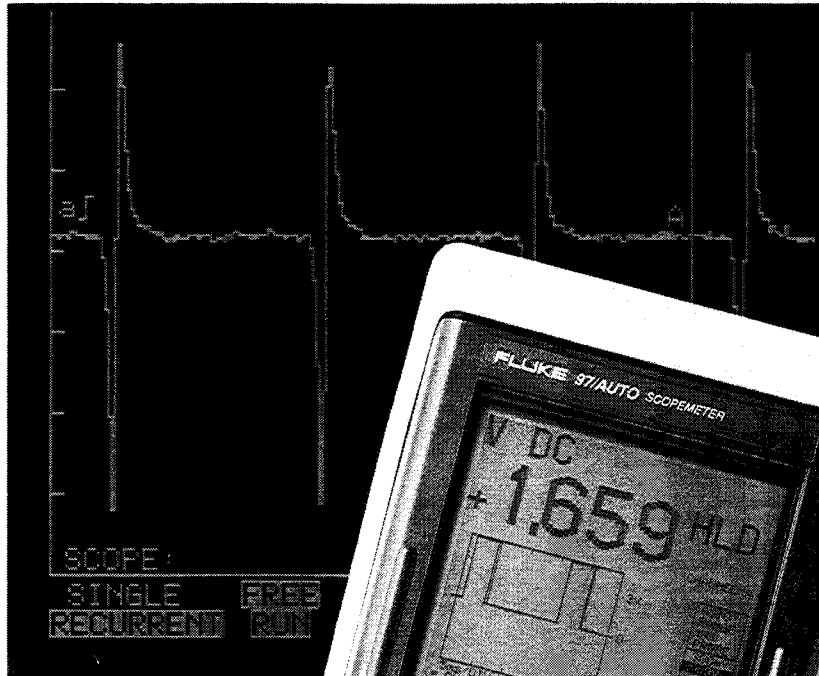

FLUKE®

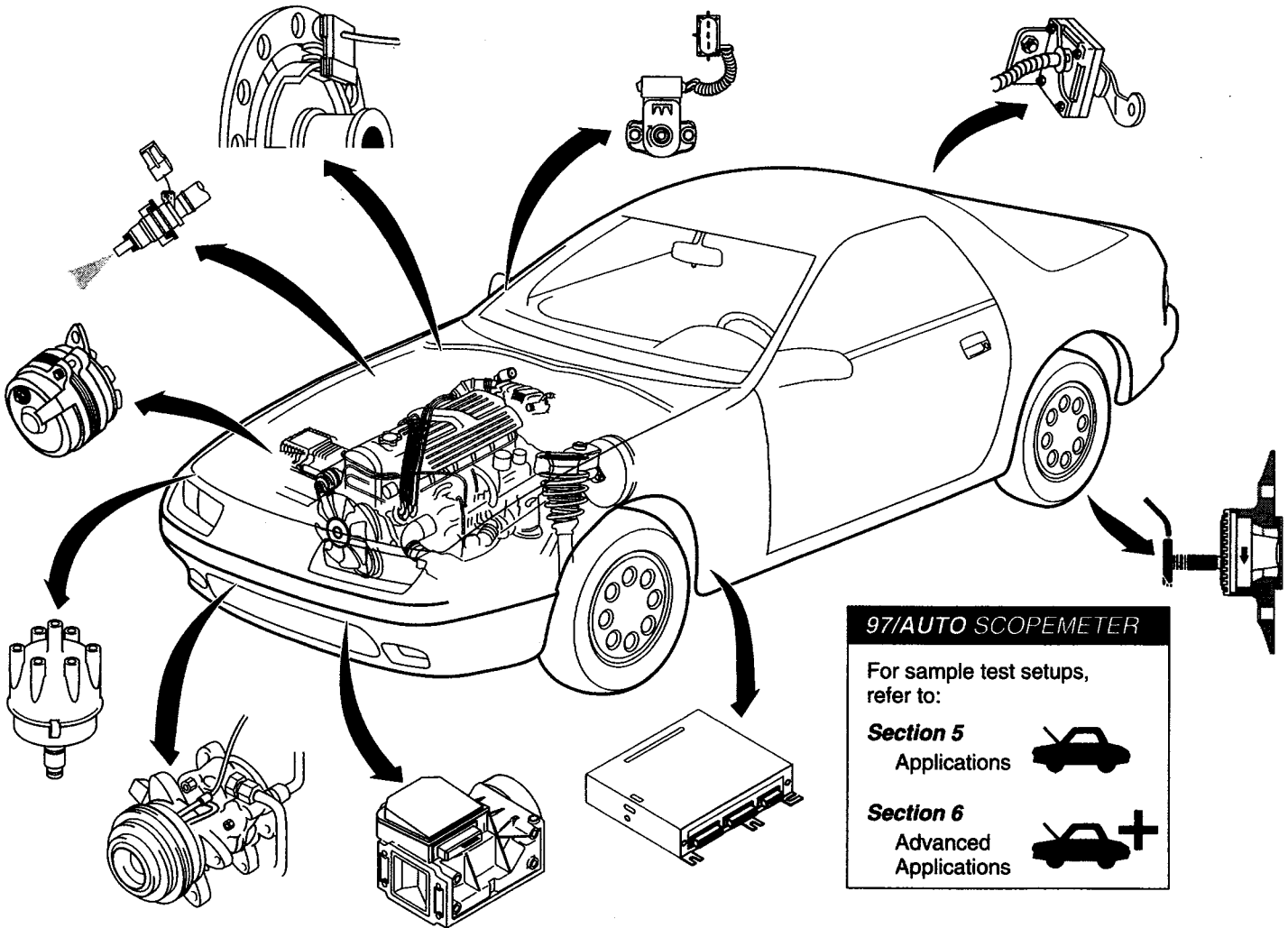

97/AUTO SCOPEMETER

For sample test setups,
refer to:

Section 5

Applications



Section 6

Advanced
Applications



97/AUTO SCOPEMETER®

USERS MANUAL









PN 932835

February 1993

© 1993 John Fluke Mfg. Co., Inc. All rights reserved. Litho in U.S.A.

FLUKE®

Table of Contents

	SECTION NAME	SECTION NUMBER
	Introducing Your ScopeMeter	1
	Using the Meter	2
	Using the Scope	3
	Additional Capabilities	4
	Applications	5
	Advanced Applications	6
	User Maintenance	7
	Appendices	8

NOTE

This manual discusses ScopeMeter setups and connections using only the Flexible Test Leads. These leads are portrayed in all example illustrations. Consequently, all setups specify selection of the 1:1 probes.

If you are using 10:1 Test Probes, consult the Probe Calibration instructions in Section 7.

ABOUT THIS MANUAL

- Section 1. Introducing Your ScopeMeter



This section introduces ScopeMeter features and capabilities. You will become familiar with ScopeMeter. You will find some more hands-on experience, with an emphasis on learning by seeing and doing.

- Section 2. Using the Meter



This section addresses specific ScopeMeter uses as a digital multimeter. You will learn how to set up ScopeMeter for ac and dc voltage measurement, diode tests, and resistance measurement.

- Section 3. Using the Scope



This section explores the use of ScopeMeter as a dual-trace, digital storage oscilloscope. You will learn how to make, store, and compare measurements.

- Section 4. Additional Capabilities



This section covers the more advanced features available with ScopeMeter.

- Section 5. Applications



This section examines some typical automotive measurements. These graphic examples can be used directly or indirectly to make many tests. Many, many more applications are possible.

- Section 6. Advanced Applications



This section looks at some things you can do using some optional accessories not included with 97/AUTO ScopeMeter.

- Section 7. User Maintenance



This section describes cleaning and battery replacement for your ScopeMeter. In addition, performance verification and 10:1 probe calibration are covered here.

- Section 8. Appendices



Appendix A. Specifications:

ScopeMeter's operating characteristics.

Appendix B. Accessories and Parts:

Kit contents and parts ordering information.

Appendix C. Warranty and Service Centers:

Warranty terms and Service Center addresses.

Appendix D. Terminology:

This Appendix defines any special terms you are likely to encounter when working with ScopeMeter.

Appendix E. Menu Trees:









Consult this appendix for a graphic view of the various softkey menus and pop-up menus and their relationship to each other.

Appendix F. Duty Cycle to Dwell Conversion:

This appendix provides a quick way to convert Duty Cycle (% , as read on ScopeMeter) to dwell.

Keystrokes

Keystrokes are represented in this manual with graphics of the keys. For example,  instructs you to press the power key. For clarity, a single key may be split into two graphics. Following are some examples of this special treatment:



 and  are used for 
 and  are used for 
 and  are used for 

You will usually be asked to “press” a key, resulting in an action (usually evidenced by a change in the display) occurring immediately. Sometimes, you will be asked to hold one key while pressing a second key.

Display Items

Usually, display items referred to in this manual are shown as seen on the display. Where this is not practical, quote marks (“ ”) are used instead.

Use of Terminology

Consult Appendix 8D, Terminology at the end of the manual for explanations of unfamiliar terms. The term ‘setup’ is used throughout this manual to identify the operating configuration when  or  is pressed or when a Master Reset or Setup Recall is performed. Subsequent keystrokes can create a new setup.

97/AUTO

Users Manual

UNPACKING

Check that the following items are included with your 97/AUTO ScopeMeter kit:

- 1 97/AUTO ScopeMeter in Yellow Holster
- 1 C97 Hard Carrying Case
- 1 Training Package
- Video
- Workbook
- Waveform Directory
- Simulator
- 1 RPM80 Inductive Pickup (for external triggering)
- 1 NiCad Battery Pack (PM9086/001, installed)
- 1 Quick Operating Guide (inside holster)
- 1 Users Manual
- 1 Universal Adapter/Charger (PM8907/008)
- 1 Automotive Power Adapter (PM9087/001)
- 1 C75 Soft Accessory Case
- 2 Banana Jack to Male BNC Adapters (PM9095/001, Red, Gray)
- 3 Large Jaw Alligator Clips (AC85A, Red, Black, Gray)

- 3 Flexible Test Leads (Red, Black, Gray)
- 3 Industrial Test Probes (TP20, Red, Black, Gray)
- 3 Banana Plug Adapters (4mm Adapter, Red, Black, Gray)
- 1 Back Probe Pin Set











Check the contents for completeness, noting whether any damage has occurred during shipment. If something in the kit is damaged or missing, contact your tool distributor immediately.

WARNING

READ "SAFETY" BEFORE USING YOUR SCOPEMETER.

SAFETY

A WARNING identifies conditions and actions that pose hazard(s) to the user; a Caution identifies conditions and actions that may damage the ScopeMeter. International electrical symbols used are explained below.

	DANGEROUS VOLTAGE		CAUTION see explanation in manual
	AC-ALTERNATING CURRENT		Equipment protected throughout by DOUBLE INSULATION or REINFORCED INSULATION
	DC-DIRECT CURRENT		
	Either DC or AC		COMMON (LO) INPUT equipotentiality
	EARTH		HIGH BNC INPUT
	FUSE	 Ni-Cd	RECYCLING

International Electrical Symbols

The terms "Isolated" or "Electrically Floating" are used in this manual to indicate a measurement in which the ScopeMeter COM (common, also called ground) is connected to a voltage different from earth ground. The term "Grounded" is used in this manual to indicate a measurement in which the ScopeMeter COM (common) is connected to an earth ground potential.

The ScopeMeter COM (common) inputs (Channel A red BNC shield, Channel B grey BNC shield, and black banana jack) are connected internally via self-recovering thermistor fault protection. The input connectors have no exposed metal and are fully

insulated to protect against electrical shock. The black banana jack COM (common) can be connected to a voltage above earth ground for isolated (electrically floating) measurements and is rated up to 600V rms above earth ground.



NOTE

This instrument contains a Nickel-Cadmium battery. Do not dispose of this battery with other solid waste. Used batteries should be disposed of by a qualified recycler or hazardous materials handler. Contact your authorized Fluke Service Center for recycling information.

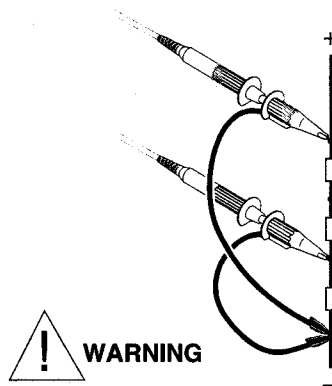

Common (Ground) Connections

USING YOUR SCOPEMETER SAFELY

Follow safe servicing practices as described in your automobile service manual. To ensure that you use your ScopeMeter safely, follow the safety guidelines listed below:

- Avoid working alone.
- Disconnect the power and discharge all high-voltage capacitors before connecting ScopeMeter for resistance measurements.
- Inspect the test leads for damaged insulation or exposed metal. Check test lead continuity. Replace damaged leads before use.
- Do not use the ScopeMeter if it looks damaged.
- Select the proper function and range for your measurement.
- Use caution when working above 60V dc or 25V ac RMS. Such voltages pose a shock hazard.
- When using the probes, keep your fingers away from probe contacts. Keep your fingers behind the finger guards on the probes.
- Disconnect the live test lead before disconnecting the common test lead.
- Do not perform internal service or adjustment of this product unless you are qualified to do so.



WARNING

TO AVOID ELECTRICAL SHOCK IF A SCOPEMETER COM (COMMON) INPUT IS CONNECTED TO >42V PEAK (30V RMS):

- 1. USE ONLY THE TEST LEAD/PROBE SET SUPPLIED WITH SCOPEMETER (OR SAFETY-DESIGNED EQUIVALENTS WITHOUT EXPOSED METAL CONNECTORS).**
- 2. DO NOT USE CONVENTIONAL EXPOSED METAL BNC OR BANANA PLUG CONNECTORS IF THE COM (COMMON) IS >42V PEAK (30V RMS).**
- 3. USE ONLY ONE COM (COMMON) CONNECTION (THE BLACK BANANA JACK).**
- 4. REMOVE ALL PROBES AND TEST LEADS THAT ARE NOT IN USE.**
- 5. USE 600V RATED PROBE TIP ADAPTERS. "600V" IS PRINTED ON EQUIPMENT SO RATED.**



WARNING

DO NOT USE SCOPEMETER IN ENVIRONMENTS WHERE EXPLOSIVE GASOLINE VAPOR MAY COLLECT (SUCH AS IN BELOW-GROUND PITS OR WITHIN 18 INCHES OF THE FLOOR.)

PHYSICAL TOUR

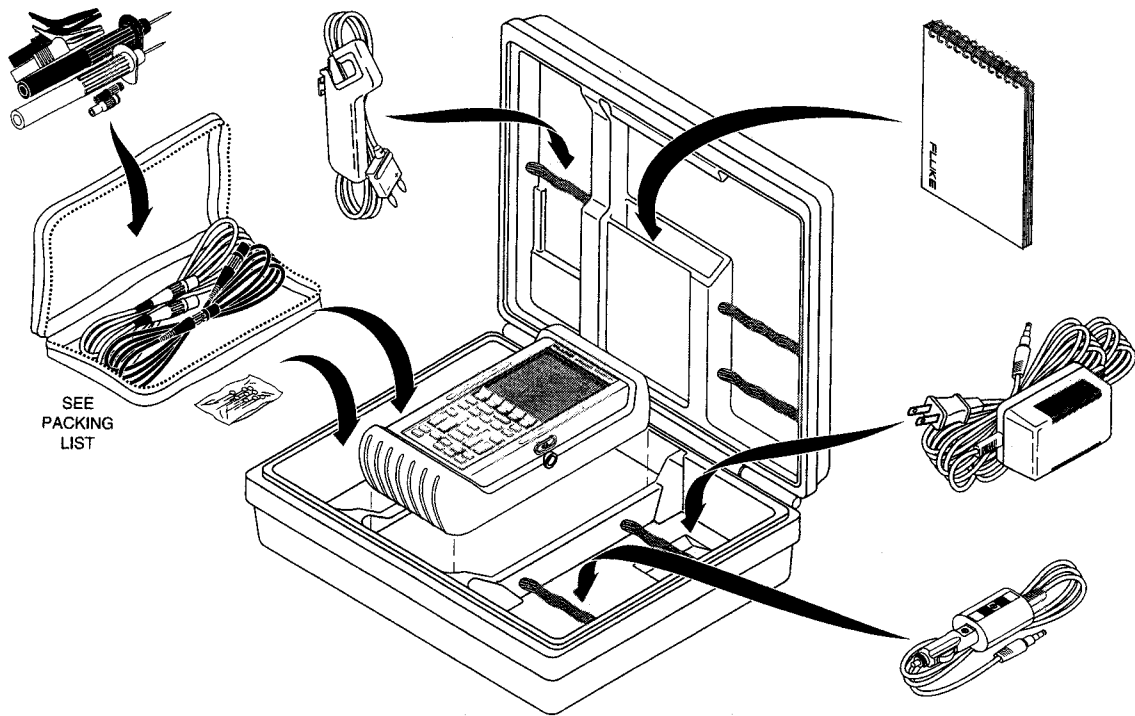

97/AUTO ScopeMeter

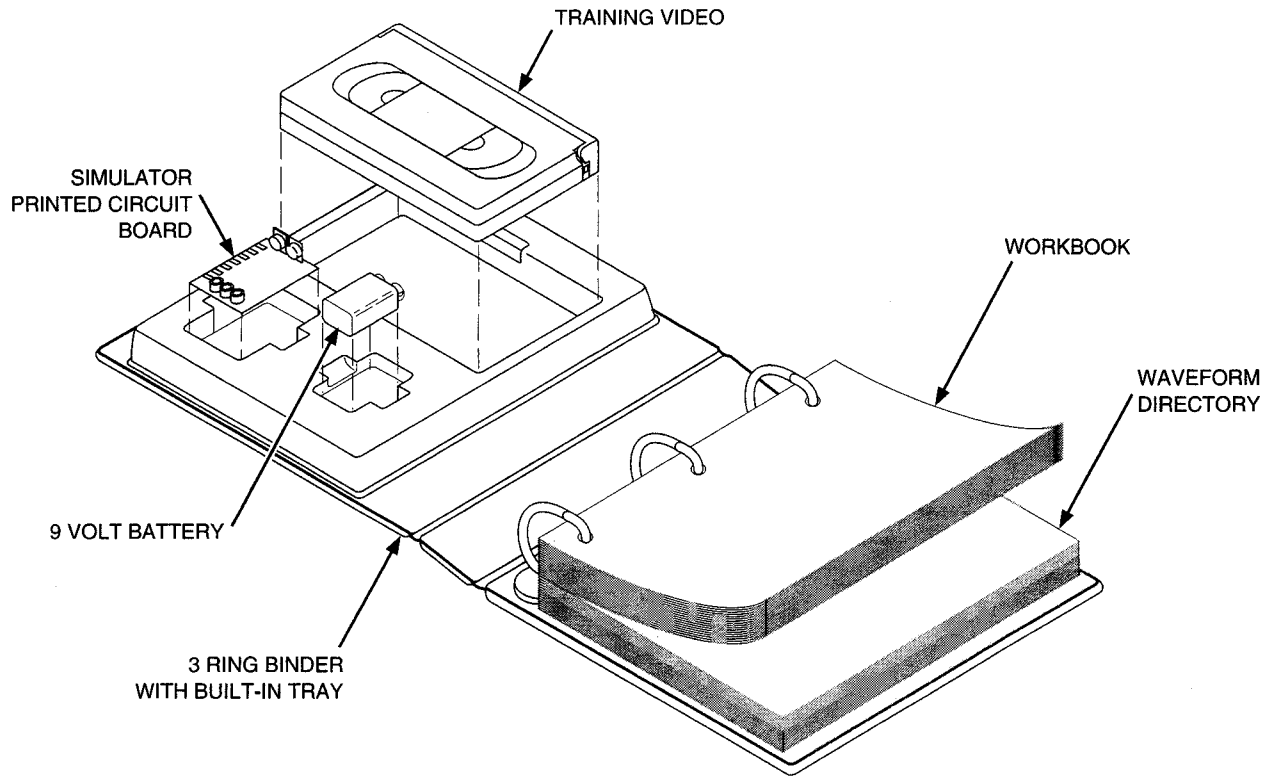

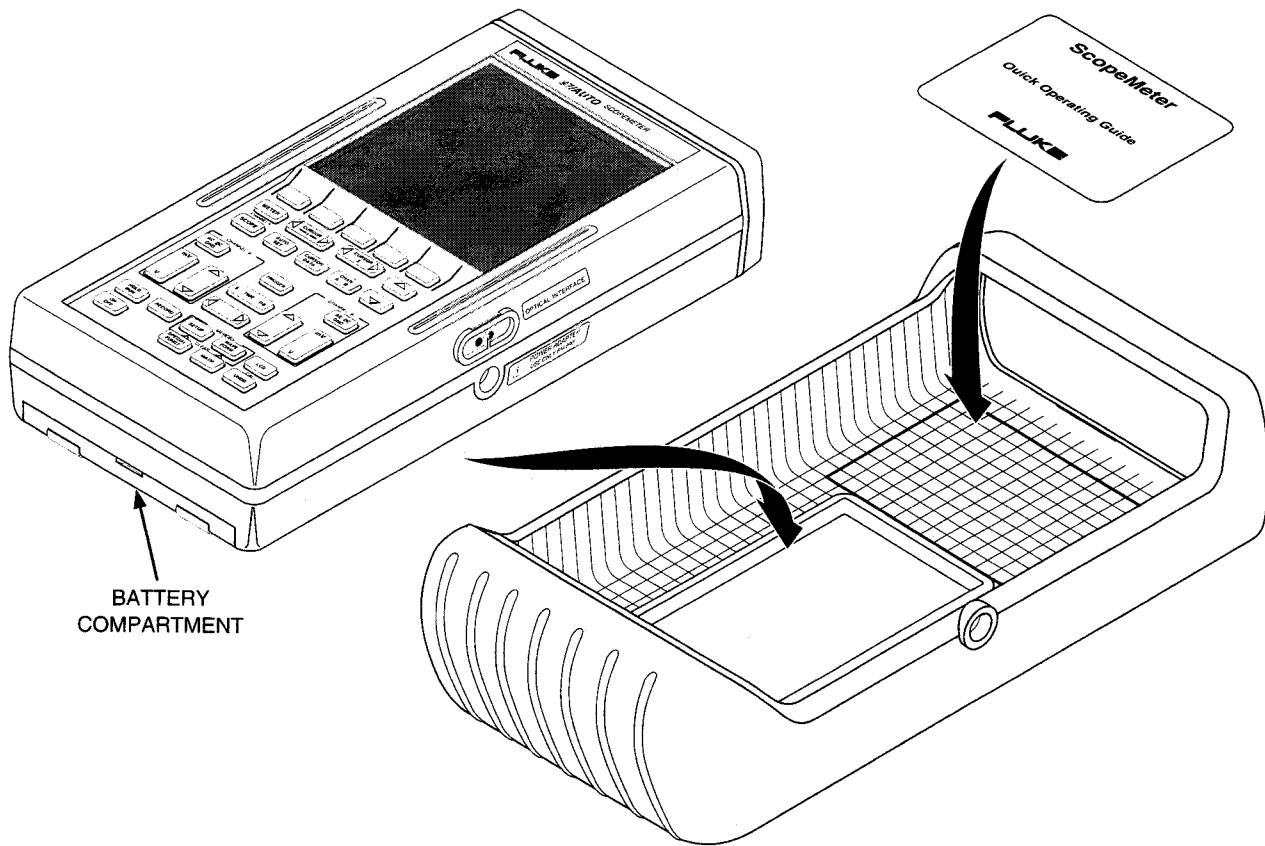

BATTERY
COMPARTMENT

97/AUTO ScopeMeter

97/AUTO
Users Manual

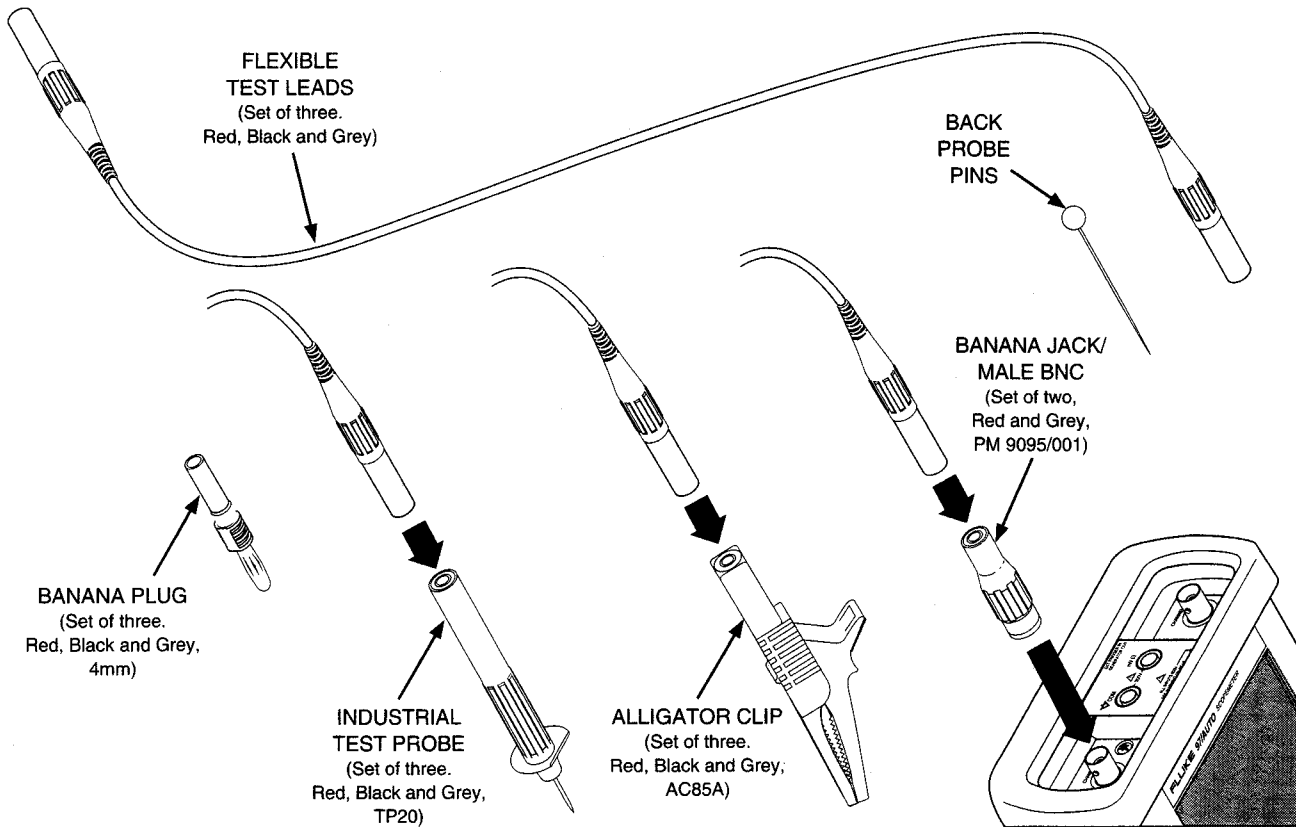

97/AUTO ScopeMeter

Quick Tour

ScopeMeter looks complicated, but it really isn't. Read through this Quick Tour first. You'll find that ScopeMeter requires you to do only as much as needed to make a measurement.

First, take a good look at ScopeMeter. You'll see a large, square display area taking up the upper half of the front. Activities on this display will be controlled by the keypad occupying the lower half of the front.

For now, just take a look at the layout of these keys. Seven unmarked blue keys appear at the top of the keypad (5 unmarked, 2 marked with arrows.) The display will define each blue key function

as you go along. Since the blue keys can do many things, they are called "softkeys". Every other key is clearly marked with its own function, which will not change.

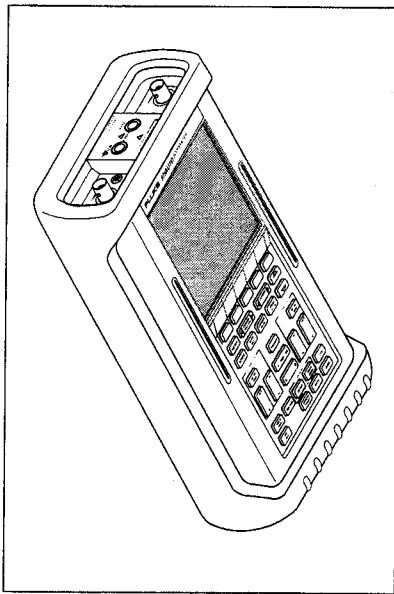

Now look at the top of ScopeMeter. You'll find a recessed area with four connection points. All measurements will be made by attaching red, black, and grey test leads and adapters (supplied with ScopeMeter) here.

Next, look at the right side of ScopeMeter. The round connection point you see here is where the ScopeMeter ac power adapter (or automotive adapter) plugs in. The oval connection point is for hooking up a printer or computer - more on that later.

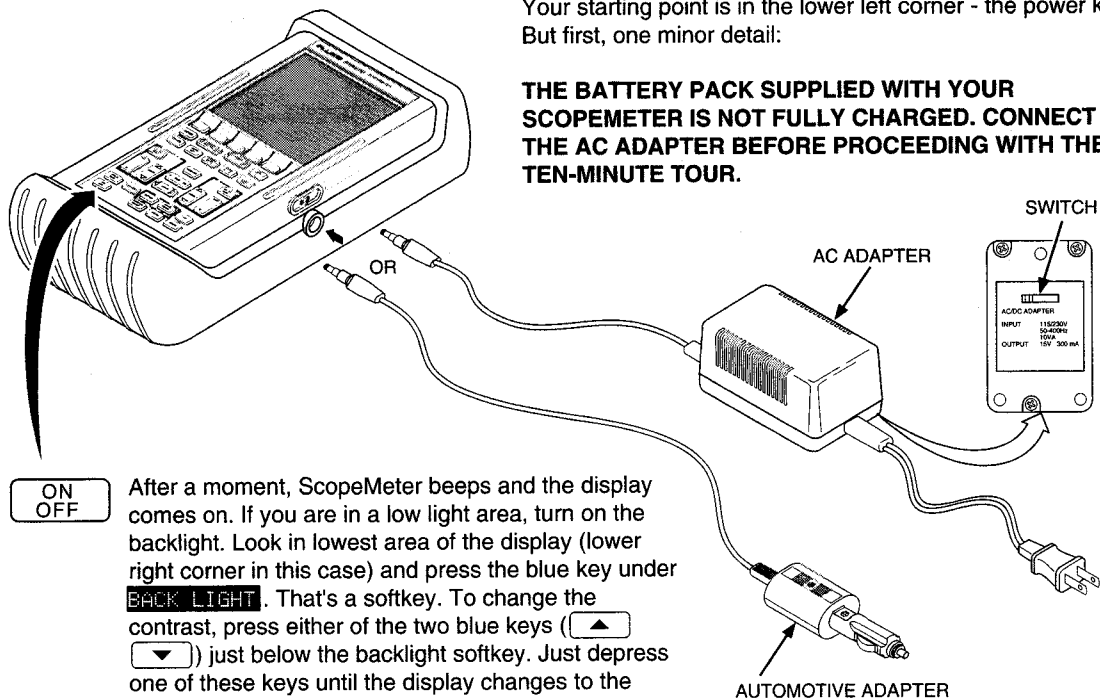

Finally, look at the back side of ScopeMeter. Pull out the tilt bracket and stand ScopeMeter up, if you wish.

Quick Tour



Your starting point is in the lower left corner - the power key.
But first, one minor detail:

**THE BATTERY PACK SUPPLIED WITH YOUR
SCOPEMETER IS NOT FULLY CHARGED. CONNECT
THE AC ADAPTER BEFORE PROCEEDING WITH THE
TEN-MINUTE TOUR.**

After a moment, ScopeMeter beeps and the display comes on. If you are in a low light area, turn on the backlight. Look in lowest area of the display (lower right corner in this case) and press the blue key under **BACK LIGHT**. That's a softkey. To change the contrast, press either of the two blue keys ( ) just below the backlight softkey. Just depress one of these keys until the display changes to the contrast you want.

Quick Tour

Look at the display now. If this is the first time you have turned on ScopeMeter, you'll see a display that looks like this:

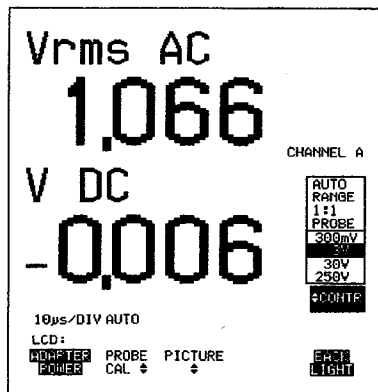

By the way, the row of definitions along the bottom of the display is called a "Softkey Menu".

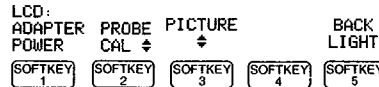

Press the middle blue softkey (3) now - you'll see a window open up on the right side of the display. This is a "Pop-Up Menu". You'll encounter these terms frequently. Softkey menus and pop-up menus work together to give ScopeMeter it's menu-driven interface.



Enough about that for now. Close the pop-up menu by pressing the middle blue key (softkey 3) again.

Now go exploring - press different keys at random and watch what happens in the display. Press about 8 different keys - the display will end up looking quite a bit different.

ScopeMeter is forgiving. You can back up through each key step you just made by pressing.

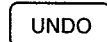

Press this key 8 times, and you're back where you started. (Actually, **UNDO** allows you to back up 10 times.)

If you get really lost, ScopeMeter provides complete forgiveness by allowing you to perform a Master Reset.

NOTE

This operation returns ScopeMeter to its factory-set configuration, erasing any changes you have made by pressing the keys. All setup and waveform memories will be erased. Later on, you'll want to remember that. But, for now, it's good to know that you can always return to a known starting point.

3. Understandably, ScopeMeter makes a Master Reset somewhat more difficult to do than just pressing one key. Actually, you'll have to press two keys, as follows:

ON
OFF

Press and hold.

LCD

Press and hold.

ON
OFF

Release.

4. ScopeMeter beeps twice and the original display, using the factory settings, returns.

Now, try three more keys, and we're done.

METER

This sets up Meter Mode. ScopeMeter becomes a big-screen digital multimeter. The blue soft-keys change to selections for the type of measurement (V_{\sim} for ac voltage, etc.). Look in Section 2 for more information on Meter Mode.

SCOPE

This sets up Scope Mode. ScopeMeter becomes a sophisticated, portable oscilloscope. Look in Section 3 for more information on Scope Mode.

AUTO
SET

This is Auto Set - another example of ScopeMeter making your job easier. In either Meter or Scope Mode, Auto Set automatically sets up ScopeMeter to present a meaningful display of a measurement input.

That's enough for now. Hopefully, ScopeMeter doesn't look that complicated after all.

Section 1

Introducing Your ScopeMeter

Contents

SCOPEMETER FEATURES.....	1-2	Backlight.....	1-12
Holster	1-2	Reverse Display.....	1-12
Tilt Stand/Bracket.....	1-3	Picture.....	1-13
POWERING SCOPEMETER	1-4	Grid.....	1-15
BATTERY CHARGING	1-5	Zoom.....	1-17
Battery Save Feature.....	1-5	MEASUREMENT CONNECTIONS	1-17
READING THE DISPLAY.....	1-6	Meter Inputs	1-17
Top Display.....	1-6	Scope Inputs.....	1-17
Main Display.....	1-7	Signal Generator Output/External Trigger Input	1-18
Bottom Display (Softkey Menu).....	1-7	Common Ground, Channels A B	1-18
Right Display (Pop-Up Menu)	1-7	Input/Output Terminal Ratings	1-18
Message Bars.....	1-8	RS-232-C Serial Interface Connection.....	1-18
SOFTKEYS AND POP-UP MENUS.....	1-8	METER MODE	1-19
USING THE KEYS.....	1-10	SCOPE MODE	1-22
Hardkeys	1-10	OPERATING CONFIGURATION	1-29
Softkeys	1-10	UNDO.....	1-29
ADJUSTING THE DISPLAY.....	1-12	SETUP MEMORY.....	1-29
Contrast	1-12		

SCOPEMETER FEATURES

Your Fluke 97/AUTO ScopeMeter® combines the capabilities of a dual-trace, digital-storage oscilloscope with the versatility of a digital multimeter. This combination allows you to analyze and compare complex waveforms, read voltage levels, or simply measure resistances.

ScopeMeter features include:

- Dual Trace, 50-MHz Bandwidth Scope
- 25 million samples-per-second, 40 ns glitch capture capability
- 3000 Count Digital Multimeter (DMM)
- Menu-Driven Interface for easy operation.
- Storage for 10 front panel setups (Meter and Scope Modes).
- Digital storage for eight waveforms.
- Simultaneous display of four waveforms (any combination of live and stored) allows for useful comparisons.

- Autoset configures ScopeMeter to select the best voltage and time base settings for a meaningful display.
- Undo feature allows you to step back through the 10 most recent key presses.
- True portability and three power source choices allow for testing in real-life environments.
- A Quick Operating Guide, found in the ScopeMeter Holster, serves as a useful reference.

Holster

ScopeMeter is cradled in a custom yellow holster that provides shock protection during rough handling. All keys and connections are accessible when ScopeMeter is in position in the holster. You will need to remove the holster only when replacing the batteries or accessing the Quick Operating Guide. (See Section 7 for battery replacement instructions.)



Tilt Stand/Bracket

ScopeMeter is equipped with a multi-purpose tilt stand, allowing for viewing from different angles. The stand can also be configured as a bracket for hanging ScopeMeter at a convenient viewing position. Simply push up on the quick release and tilt the stand. The tilt stand/bracket is fully usable with the yellow holster fitted on ScopeMeter. Typical uses are shown in Figure 1-1.

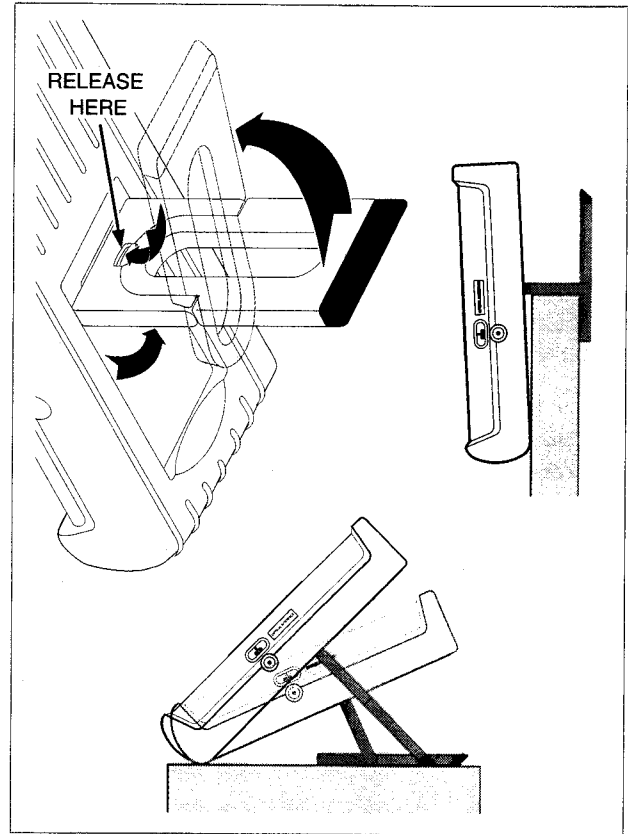

Figure 1-1. Multi-Position Bracket

POWERING SCOPEMETER

ScopeMeter can be powered from any of the following sources. Refer to Figure 1-2.

- Internal Battery Pack

A PM9086/001 NiCad battery pack installed in your ScopeMeter.

- C Cell Batteries

You can use four alkaline batteries in place of the NiCad Battery Pack. (The charger is automatically defeated when C cells are installed.)

- AC Adapter

The PM8907/008 Power Adapter/Battery Charger powers ScopeMeter from a standard ac outlet (115/230V ac). Set the slide switch on the adapter to "115" or "230" before using the Power Adapter/Battery Charger to power ScopeMeter and/or charge the battery pack. ScopeMeter can be used during battery charging.

- Automotive Adapter

The PM9087/002 powers ScopeMeter from a standard 12V dc automotive accessory (lighter) outlet.

Refer to Section 7 for battery replacement instructions.

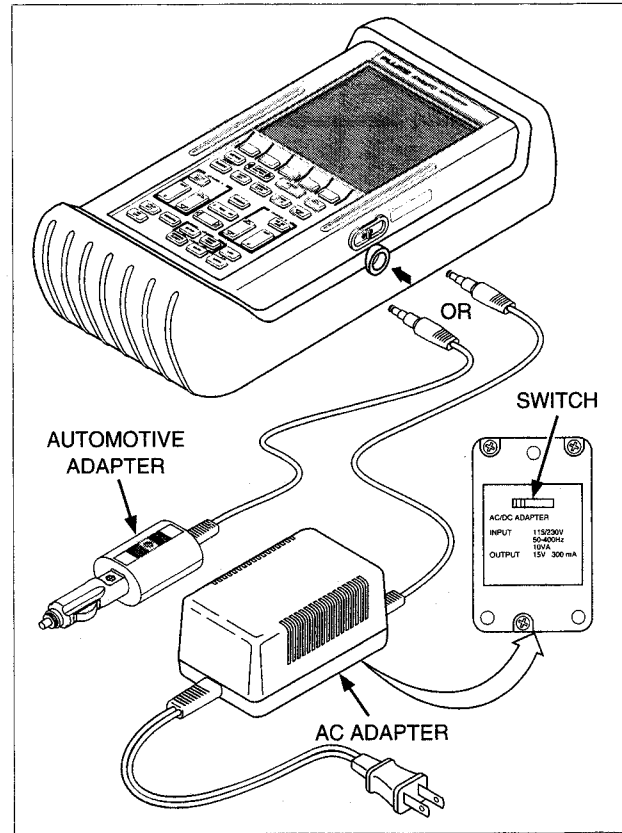

Figure 1-2. Power Connections



BATTERY CHARGING





WARNING

USE ONLY A BATTERY CHARGER THAT IS AUTHORIZED FOR USE WITH SCOPEMETER.

Use the following procedure to charge the battery pack and power the instrument:

1. Insert the PM8907/008 Power Adapter/Battery Charger low voltage plug into ScopeMeter's POWER ADAPTER connector. Set the slide switch on the adapter to "115" or "230", depending on your line voltage.
2. Connect the PM8907/008 Power Adapter/Battery Charger to line voltage. ScopeMeter can now be used while the NiCad Battery Pack charges slowly. If ScopeMeter is off, the Battery Pack charges more quickly.

At power on,  **POWER** or **ADAPTER POWER** is displayed to indicate the power source.

During operation when the batteries are low, a blinking battery symbol () appears in the lower left corner of the display.

Battery Save Feature

When operated only on batteries, ScopeMeter conserves power by beginning to shut itself down if no new key entries are made for five minutes or if the battery level is too low. ScopeMeter beeps and momentarily displays the following message bar:

ScopeMeter auto shutdown in 5 minutes!!

If no key is pressed during the next five minutes, ScopeMeter turns itself off automatically. When  is pressed ON, the display configuration in effect before the automatic shutdown is restored.

If ADAPTER POWER is connected, there is no automatic power shutdown; ScopeMeter can be left on with no periodic key press requirements. If Meter Record or Scope Record mode is on, the automatic shutdown feature is disabled. ScopeMeter continues recording even if no new key entries are made. Although recording will continue if the batteries are low, retention of waveform and setup memories is not jeopardized.

READING THE DISPLAY

The ScopeMeter display presents you with a great deal of information. Of course, the major part of the display will always be devoted to the meter reading or scope waveform. The top, bottom, and right-side display areas will describe the reading or waveform much more precisely. Refer to Figure 1-3 during the following discussions.

Top Display

The Top Display appears as two rows of information when ScopeMeter is in Scope Mode. (The Top Display is not used in Meter Mode.)

The top row identifies the voltage amplitude per vertical division on the display, the type of signal coupling (AC, DC, or GND), and the selected probe type (usually 1:1 or 10:1) for channels A and B. For example,

A 100mV DC 10:1 PROBE B 200mV AC 1:1 PROBE

means that channel A is set to display 100 mV per vertical division with dc signal coupling using a 10:1 probe and that channel B is displaying 200 mV per vertical division with ac signal coupling using a 1:1 probe.

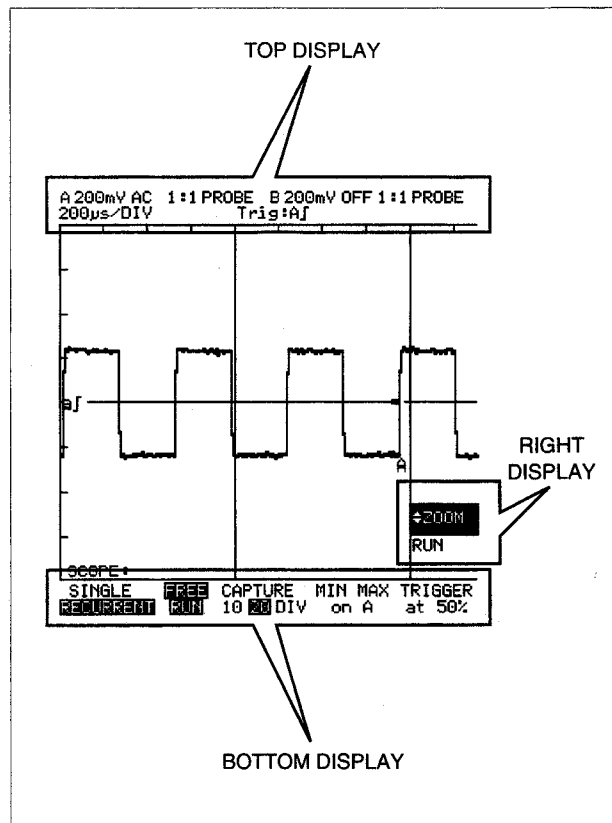

Figure 1-3. The Display in Scope Mode



The bottom row of the top display identifies the time scale for each horizontal division and information about the trigger source and slope. For example,

20ms/DIV Trig:A]

means that each horizontal division represents 20 ms (milliseconds) and that channel A is being used as a trigger source with a positive slope.

Main Display

In Meter Mode, the Main Display always shows some form of the measurement input. (Only the input on Channel A can be displayed.)

In Scope Mode, up to four waveforms can be displayed at the same time. A displayed waveform can be a live input on Channel A or B, any of eight stored waveforms, or a combination of both.

Bottom Display (Softkey Menu)

The Bottom Display provides the softkey menu name and a definition for each softkey.

Right Display (Pop-Up Menu)



The Right Display depends on the ScopeMeter setting. In Meter Mode, type of ranging, probe selection, and range setting are displayed. Pop-Up Menus (accessed via the softkeys) also appear in the Right Display. A menu may overwrite all or part of the standard right display.

Pop-up menus are used extensively to display choices accessed with a related softkey. On the menu, a large, bold square appears to the left of a selected item. A small square appears next to a non-selected item. Sometimes, no marking appears next to an item, indicating that the item cannot be selected at this time. For example, if a waveform memory is empty, the memory cannot be recalled and is not selectable.

NOTE







If no selection is made, the pop-up menu closes automatically after about 30 seconds.







Some pop-up menus allow for only one selection from the displayed list. The menu closes after the selection is made. Other menus offer different categories of selections, allowing for multiple selections. Differences between these two types of menus are as follows:

- Where only one menu selection is possible, press   to highlight (reverse video) a selection. Make sure this choice is correct, then press  (ENTER). The menu closes as the new selection is made.

You can verify the new selection by recalling the menu. If the large square appears next to the



correct menu choice, press the chosen menu softkey again to close the menu.

- Where multiple selections are possible from the same menu, each selection must be made individually; press   to highlight the selection, and  (ENTER) to make the selection. A large square appears next to the new selection, and the menu remains on the screen. Pressing   , you can repeat this procedure as required. Verify the new selections, then close the pop-up menu and activate the selections by pressing the same softkey.

For example, from the Scope Mode, press  and  to access the Cursor Data Function selections. Then make a maximum of five individual selections by pressing  and , then  (ENTER). Finally, press  again to exit the pop-up menu and activate the selections.

- In some multiple selection pop-up menus, each selection change closes the menu and returns ScopeMeter immediately to the full display. Typically, only one or two of the selections will be active at one time; therefore, this sequence speeds overall key pressing.

You must reaccess the menu to make the next selection. The cycle for each selection is as follows:

1. Press the appropriate softkey to access the pop-up menu.
2. Press   to highlight the selection. Note that an inactive item has a small dot to the left. An active item has a large square to the left.
3. If you want to change the highlighted selection, press  (ENTER). The menu closes and the inactive small dot or active large square state of this selection is switched.

If you just want to verify existing selections, press the softkey first to look at the menu, then press it again to exit the menu without making changes.

Message Bars

On certain occasions, a one-line message appears in the Bottom Display. For example, if the key you just pressed cannot be used at this time, you will see the following response:

Key not possible in this ScopeMeter mode

SOFTKEYS AND POP-UP MENU

Softkeys and pop-up menus work together to provide a complete menu-driven interface. This manual presents many illustrations showing the hardkeys, softkeys, and pop-up menus that must be used for each setup procedure. The hardkeys are shown in



the far left column. You press the first hardkey shown to access the softkey menu; you press the last hardkey shown to exit the procedure and return to your starting place. In between hardkeys, you are presented with the softkey choices and the accompanying pop-up menu.

For example, press **METER** and follow the softkey and pop-up menu sequence shown here. In this case, your next step is to press any of the softkeys shown to select a function. Then press **SOFTKEY 1** to access the Display Modes Pop-Up Menu. Next, press **▼** to highlight a selection in the menu, followed by **SOFTKEY 5** (**ENTER**) to activate the selection. Finally, press **METER** again to return to your starting place.

NOTE

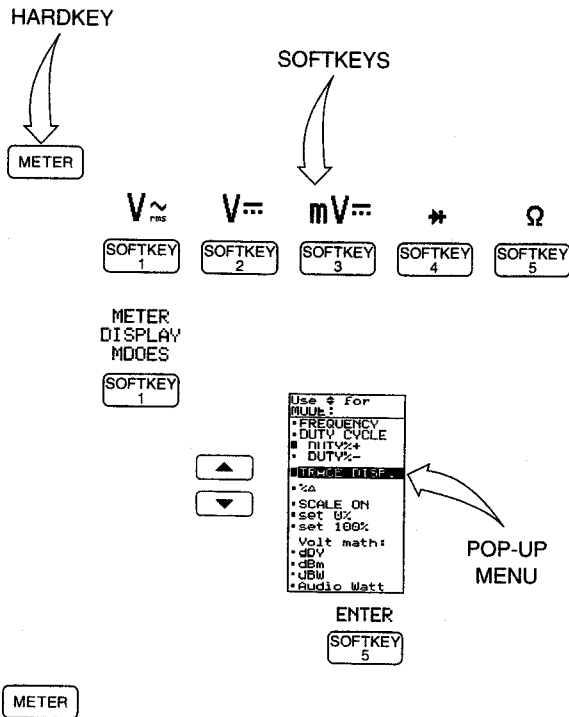

Key sequence and pop-up menu descriptions are illustrated throughout this manual in the pattern you see here. The last key shown in these examples provides a return path to a common starting point (Meter Mode or Scope Mode.)





USING THE KEYS

Refer to Figure 1-4 for a view of the keys being discussed in the following paragraphs.

Hardkeys







Hardkeys are used for specific operations and are clearly marked with a name. A hardkey does the same thing each time it is pressed. For example,  always selects Meter Mode,  always accesses the LCD Softkey Menu, and  always performs an AUTO SET.







Some hardkeys are used only in Scope Mode; they cannot be used when ScopeMeter is in Meter Mode. For example,  can only be used for Scope Mode math operations, and  can only be used for Scope Mode waveform operations. ScopeMeter does not accept this type of key press in Meter Mode; a “beep” results and the following is momentarily displayed:

Key not possible in this ScopeMeter mode

Softkeys

Each blue softkey is used for a variety of operations and is, therefore, not marked with a specific name. ScopeMeter uses seven softkeys. (You can think of them as function keys on a computer.)

Although not so marked, the five blue keys along the top of the keypad are referred to (from left to right) as     . This approach simplifies references in this manual. The current use for each key is always identified in the lower portion of the display. For example, when  is pressed,  can be used to access the PICTURE Pop-Up Menu.

Two other blue softkeys ( and ) allow you to sequence through selections shown on the display. The  icon appears in the display to identify the current use for these two softkeys. For example, when you enter Meter Mode, RANGE means that  and  can be used to select the measurement range.

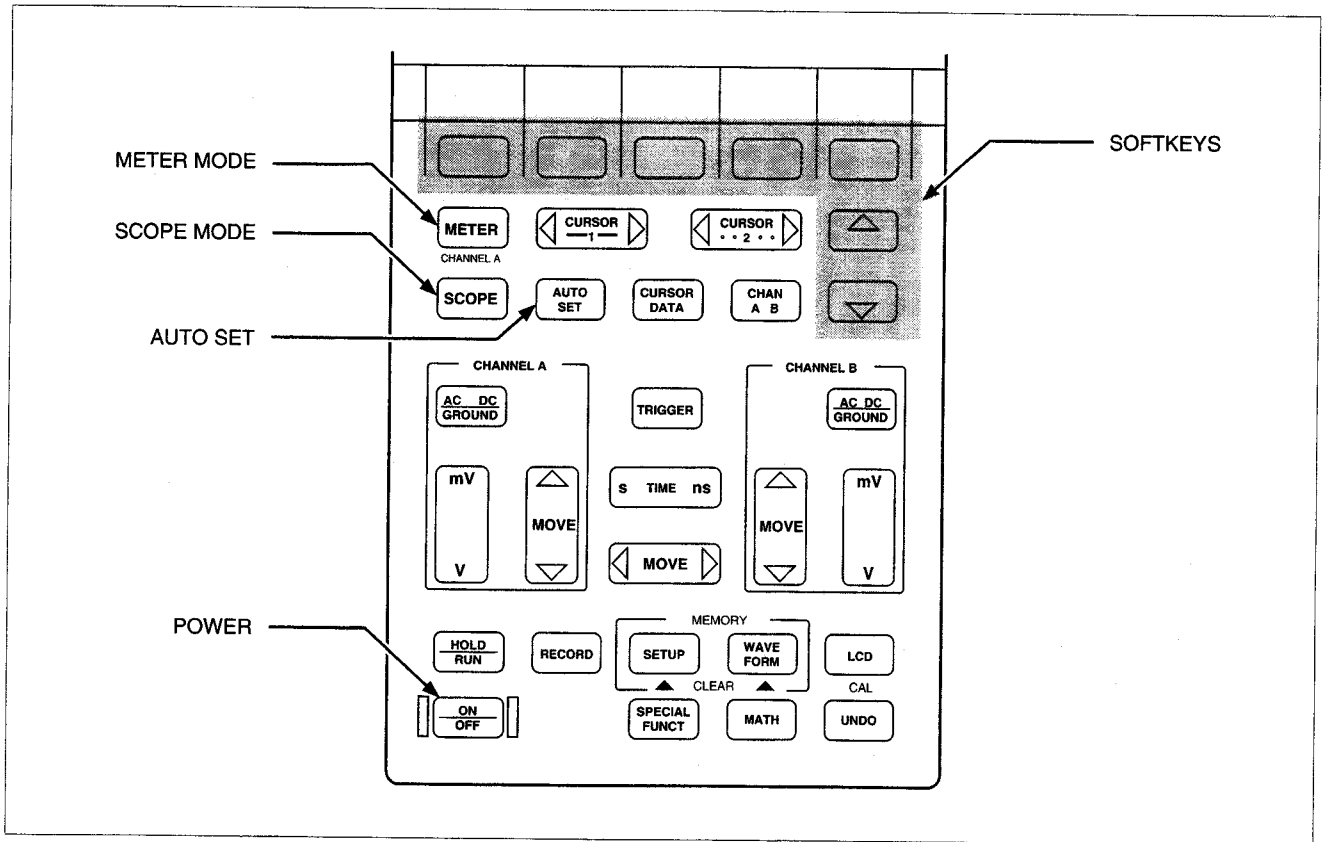
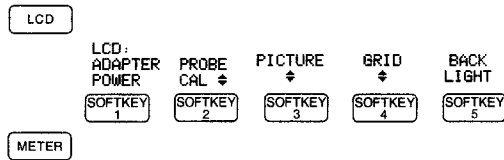

Figure 1-4. The Keypad

ADJUSTING THE DISPLAY

When the LCD display first comes on (is pressed ON or when is pressed), the LCD Softkey Menu appears. This menu allows you access to some basic tools for controlling the display format.



LCD Softkey Menu

NOTE

At turn on, POWER or ADAPTER POWER is displayed to indicate the power source. Although one of these identifiers appears above , the power source is not a softkey selection.

Several settings allow you to adjust the display for optimum viewability.

Contrast

When is present in the Right Display, you can press or to adjust the balance of display information and display background to your liking. Press to intensify information on the full display. Press to deemphasize display information. By holding either key depressed, you can also cycle through the full contrast range.

Backlight

You can control the backlight after is pressed or whenever is pressed. At these times, press to activate or deactivate the backlight. Note that using the backlight on battery power will shorten ScopeMeter operating time by about 1/2 hour.

Reverse Display

The normal display presents dark information on a light background. You can also reverse this arrangement, presenting light information on a dark background. This choice is available after is pressed or whenever is pressed. Press , then press or to highlight REVERSE in the Right Display. Finally, press (ENTER) to make the selection.



Picture

From the Scope Softkey Menu, selections available in the Picture Pop-Up Menu directly impact the clarity of the waveform. Take a moment to investigate these selections.

In most cases, you will want to use the default setting (DOT JOIN). This selection fills in the blanks between sampling points on the display, yielding a continuous waveform. The density of this display can be controlled with DOTSIZE. DOTSIZE 2 yields a display that can be easily seen in most lighting conditions. Choose DOT SIZE 3 for a denser display. DOTSIZE 1 could be used to avoid a cluttered display if several waveforms are shown. Figure 1-5 shows the effects of Dot Join on display clarity.

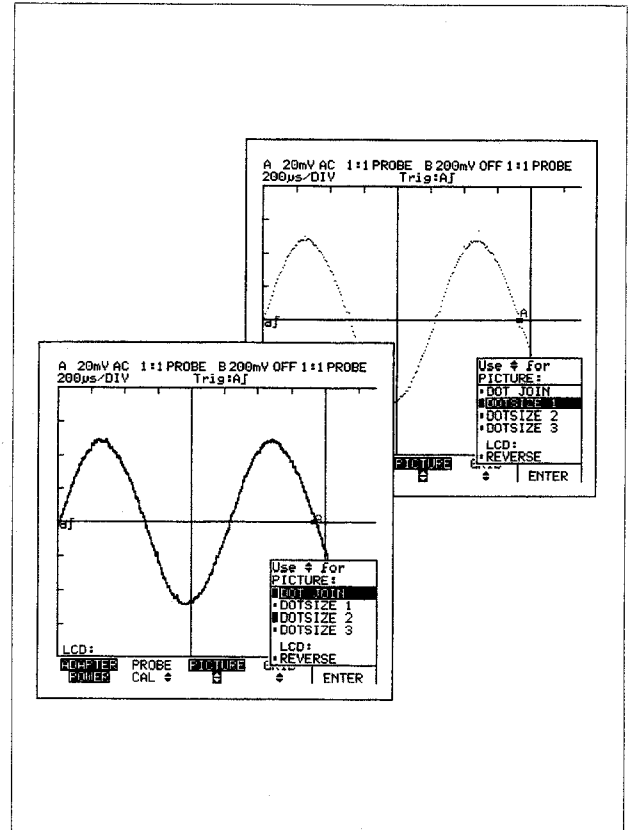
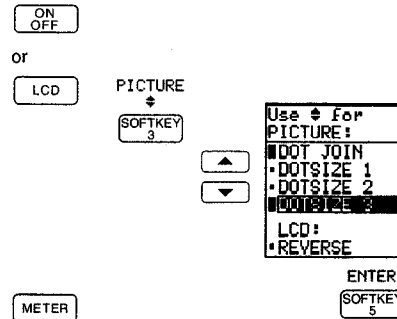

Figure 1-5. Dot Join

Also, try the REVERSE selection to present the waveform as a light line on a dark background. With a suitable dot size, the reverse display may provide an easier to read waveform. This will be especially true when you are looking for extremely fast occurrences (glitch capture.)

For automotive applications, always use DOT JOIN so that dots representing measurement samples can be joined to yield a continuous waveform. DOTSIZE 1 or DOTSIZE 2 both yield a legible display. Use DOTSIZE 3 for environments where lighting is poor or where you are viewing ScopeMeter from a distance. DOTSIZE 1 is the default setting.



Picture Pop-Up Menu



Grid

In Scope Mode, the ScopeMeter display can be configured for one three sets of reference lines. These configurations are described in the following pages and illustrated in Figure 1-6.

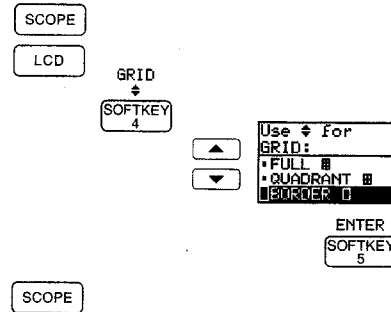

Grid Pop-Up Menu

- **BORDER** provides only a perimeter line with time and amplitude division marks. This is the most uncluttered view of the waveform.
- **QUADRANT** adds horizontal and vertical centerlines as additional reference points to the border display. You will probably find that this selection presents the most meaningful waveform display.
- **FULL** adds a crosshatch pattern based on the horizontal time and vertical amplitude divisions on the display. This is the traditional oscilloscope pattern and is useful in identifying areas of the waveform.

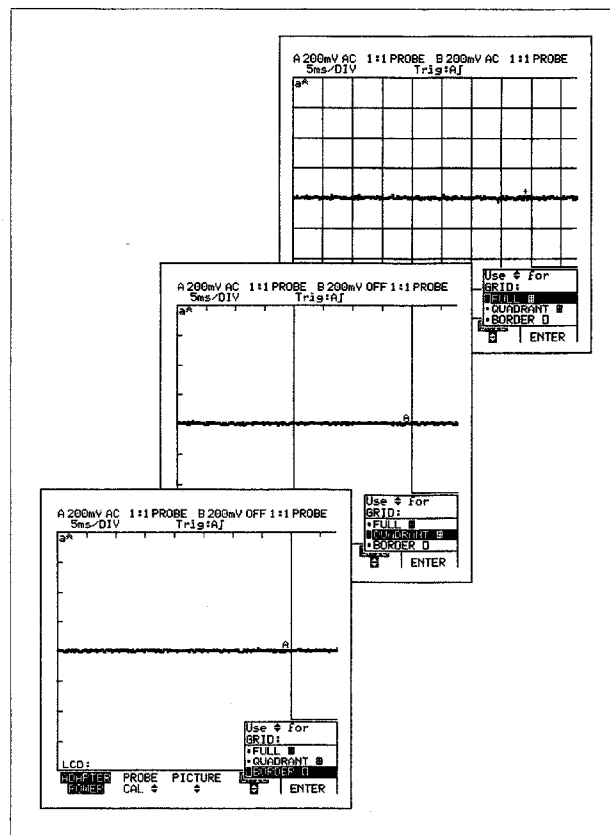

Figure 1-6. Grid Patterns



Zoom

Press **SCOPE** and look for **ZOOM** in the Right Menu area. Then press **▲** to enlarge the waveform (decreasing the time base) or **▼** to shrink the waveform (increasing the time base.) The time base is adjusted one step at a time and, if necessary, the trigger delay is recalculated. The focal point for this activity is waveform activity at the fourth time division (midpoint on the display.) The Zoom feature is useful as a quick examination of a live waveform. Zoom cannot be used on stored waveforms recalled from memory.

MEASUREMENT CONNECTIONS

ScopeMeter provides four signal connection points: two BNC safety inputs (CHANNEL A and CHANNEL B) and two safety banana jack inputs (COM and $mV \Omega$). This arrangement is shown in Figure 1-7. All four connections are positioned within a protective recess at the top of the instrument.

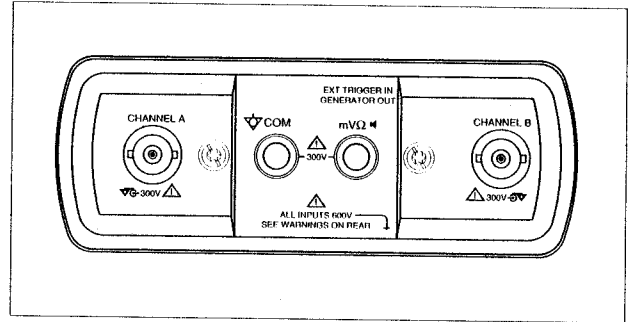

Figure 1-7. Measurement Connections

Meter Inputs

In Meter Mode, ScopeMeter accepts inputs at the red safety CHANNEL A BNC jack for V_{\sim} and V_{\rightleftharpoons} measurement functions. The red safety banana jack is used for mV , \ast , and Ω measurement inputs.

Scope Inputs

In Scope Mode, ScopeMeter accepts inputs on Channel A or Channel B. The red safety BNC jack is used for Channel A, and the grey safety BNC jack is used for Channel B. A single BNC-to-safety banana jack adapter is used at each jack. Ground is connected at the black safety banana jack.

Signal Generator Output/External Trigger Input

Outputs from and inputs to this connection are used for the following purposes:

- **External Trigger Source**

The red banana connector also serves as an input connection for an external trigger in Scope Mode (using an RPM-80 Inductive Pickup.) The Signal Generator can also be used as an internal trigger source for ScopeMeter; this arrangement does not require a physical connection at the terminals.

- **Component Measurement**

The Signal Generator can be configured to provide voltage or current to components. (Refer to the Specifications in Appendix 8A for voltage and current level information.) ScopeMeter then monitors these components. This technique is dealt with further in Section 4.

NOTE

ScopeMeter's output levels do not allow you to use the Signal Generator outputs to power automotive sensors. However, certain component tests are possible.

Common Ground, Channels A B

ScopeMeter uses a three-lead connection system for dual channel, isolated (electrically floating) measurements.

Input/Output Terminal Ratings

Maximum voltage ratings are defined on ScopeMeter near the related terminal. Refer to the Specifications in Appendix 8A for complete terminal rating information.

RS-232-C Serial Interface Connection

An optically isolated interface adapter can be connected to ScopeMeter for printer output and computer interface. This adapter is included in the 97/AUTO Accessory Kit (K97A).



METER MODE

You are ready for some hands-on ScopeMeter use. Start with Meter Mode; press **METER**.

ScopeMeter now displays one or more digital readings. Figure 1-8 presents a typical Meter Mode display.

Read “Learning Meter Mode” in this section for an introduction to Meter Mode. Refer to Section 2 for an in-depth look at Meter Mode.

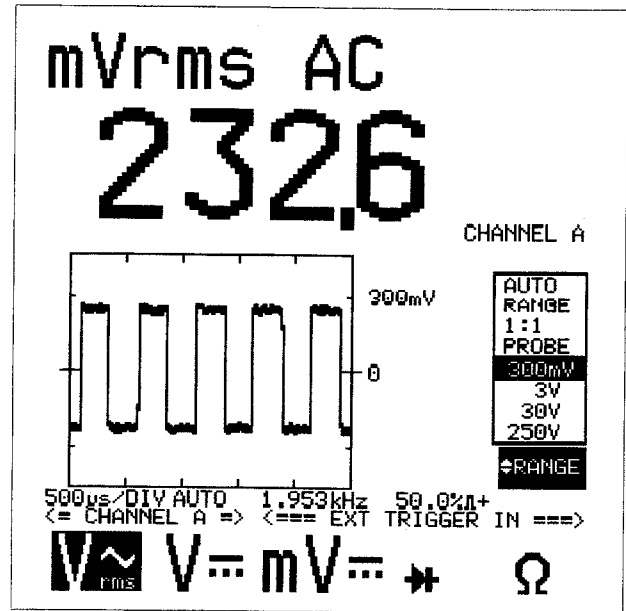
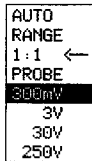

Figure 1-8. Meter Mode



Press power ON. After a moment, ScopeMeter beeps and the display lights up.

Look for 1:1 in the Pop-Up Menu (Right Side Display)



If 10:1 appears, press OFF. Press and hold , then press and release . ScopeMeter beeps once; 1:1 appears now.



Activate Meter Mode. All five softkey definitions in the bottom display now change to meter function identifiers.

V_{DC}



Choose the dc voltage measurement function. (The softkey definitions change again.)



V_{AC}



Choose another function.



Change the measurement range while ∇ RANGE is displayed. Press the down arrow key twice, leaving ScopeMeter in the 30V range.

Learning Meter Mode



HOLD
RUN

Press this key once to freeze the displayed measurement. HLD appears on the display.

HOLD
RUN

Press **HOLD RUN** again to resume new measurements.

RECORD

Press this key once to start recording the maximum (MAX), average (AVG), and minimum (MIN) measurements.



RECORD

Press **RECORD** again to stop recording.

SETUP

Now you are going to save the present ScopeMeter operating configuration in memory. (This is the setup assumed at power on, as changed by other keystrokes up to this point.)

SOFTKEY
2

Make sure Setup 1 is highlighted. If necessary, use  or  to move the highlight bar.

SOFTKEY
5

You have just stored the ScopeMeter operating configuration in Setup 1 memory. You can return to this setup later (and avoid pushing the same keys again) by simply recalling this setup. Later in this section, you will see how to deal with up to ten different setups in this fashion.

AUTO
SET

ScopeMeter automatically assumes a new setup - one that is optimized for measuring the actual input signal. With no input, the lowest range (300mV) is activated.

CURSOR
DATA

Key not possible in this ScopeMeter mode Some keys can only be used in Scope Mode. ScopeMeter operation continues uninterrupted. After a few seconds, this message clears itself from the display.

ON
OFF

Press this key to turn ScopeMeter off.

Learning Meter Mode

SCOPE MODE

Press **SCOPE**. The ScopeMeter display now appears as an oscilloscope screen. See Figure 1-9 for an example display. The display shows amplitude over time.

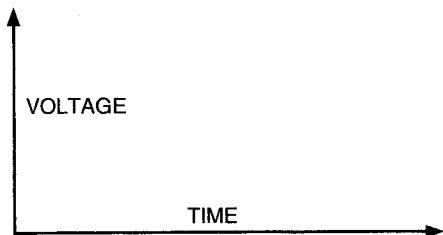

Voltage vs. Time

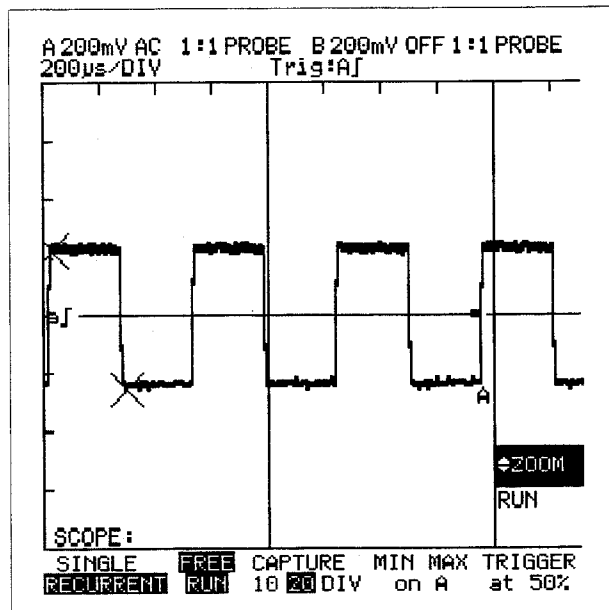

Figure 1-9. Scope Mode

Read "Learning Scope Mode" in this section for an introduction to Scope Mode. Connect the ScopeMeter GENERATOR OUT to CHANNEL A as shown in Figure 1-10. Section 3 discusses Scope Mode in greater detail.

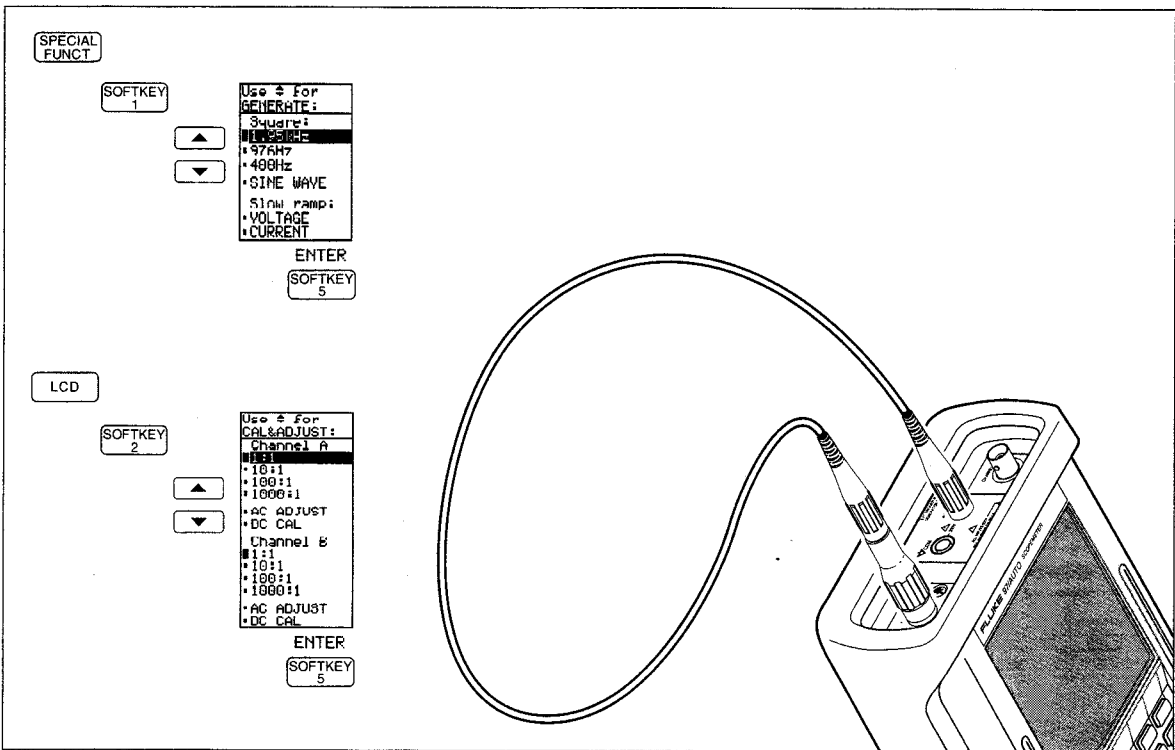

Figure 1-10. Scope Mode Demonstration Connections

ON
OFF

Press power ON. After a moment, ScopeMeter beeps and the display lights up.

Look for 1 : 1 in the Pop-Up Menu (Right Side Display)

```
AUTO
RANGE
1:1 ←
PROBE
300mV
  3V
 30V
250V
```

If 10 : 1 appears, press OFF. Press and hold , then press and release . ScopeMeter beeps once; 1 : 1 appears now.

SCOPE

Activate Scope Mode. Turn the signal generator on via the Special Functions Softkey Menu and the Generator Pop-Up Menu. by using the following keystrokes:

SPECIAL
FUNCT

SOFTKEY
1

Press to highlight 1 . 95kHz.

SOFTKEY
5

Activate the selection.

CHAN
A B

Verify that channel **B** is selected for display. If B is on, press to deselect it.





AUTO
SET

Use the Autoset feature to display a waveform. ScopeMeter automatically selects timebase and amplitude to optimize display of the waveform.

LCD

PICTURE

SOFTKEY
3

Use    (ENTER) to experiment with different waveform display possibilities.



SOFTKEY
4

Use    (ENTER) to experiment with different grid backgrounds.

SCOPE

Return to the Scope Mode Softkey Menu.

◀ MOVE ▶

Check that CAPTURE 10 is highlighted above . Then hold  to shift the waveform right-to-left across the screen. Appearing on the right, a flat line begins to replace the waveform. Release the key when most of the waveform has been replaced by this flat line.

CAPTURE
10 20 DIV

Select CAPTURE 20 by pressing  once. The waveform returns as an additional 10 time divisions of signal are displayed. You can now shift the waveform right or left considerably, resulting in a virtual double screen display.

SOFTKEY
3

MIN MAX
on A

Turn on MIN MAX to set ScopeMeter to its fastest sampling rate. This feature is very useful in viewing glitches - extremely brief events relative to the waveform timebase.

SOFTKEY
4

SOFTKEY
4

Turn off MIN MAX.

Learning Scope Mode

TRIGGER

Take a look at the Trigger Softkey Menu now.

GEN
A B

SOFTKEY
1

Choose a trigger source. For now, select A and continue on. If B is selected, the waveform wanders - there is no input on channel B. If GEN is selected, ScopeMeter's signal generator supplies the trigger source.

+SLOPE
-SLOPE

SOFTKEY
2

Begin display as the waveform rises above the trigger level (+SLOPE) or falls below the trigger level (-SLOPE). Watch the display - the pattern starts at a different place as trigger + or - is selected.

TRIGGER
LEVEL

SOFTKEY
3

Press to adjust the trigger level. The level is displayed below \updownarrow LEVEL in the Right Display. Look at the left edge of the display as you press and ; the \updownarrow icon moves as you change the trigger level. TRIGGER LEVEL can be set only when the trigger source is channel A or B.

SCOPE

Some trigger-related choices are also available from the Scope Mode Softkey Menu:

FREE
RUN

SOFTKEY
2

With Free Run ON, ScopeMeter supplies its own trigger if one is not available from the selected source.

Learning Scope Mode



TRIGGER
at 50%

SFTKEY
5

Chooses a trigger point at 50% of the input signal.

CURSOR
DATA

Now go directly to the Cursor Data Softkey Menu.

CURSOR

SFTKEY
3

Turn on the cursors (two vertical lines - bars on the left, dashes on the right.) Selected function readings of waveform activity between the cursors appear in the right display area. Horizontal cursors track the signal automatically as the vertical cursors are moved.

FUNCTION

SFTKEY
2

Press this key to take a look at the functions (types of activity) that you can measure with the cursors. Press to highlight a function. Press ENTER to select that function. Repeat this procedure to select a maximum of five functions.

SFTKEY
2

Press a second time to deselect the pop-up menu.

CURSOR
-1-

Move the cursors back and forth, and watch the readings change in the right display area.

CURSOR
-2-

mV
v

For CHANNEL A, try changing the amplitude used for each division of the vertical scale. These divisions are marked along the left side of the display. The amplitude setting is shown in the first line of the top display.

s TIME ns

Now change the time base - the amount of time is represented by each horizontal division shown along the top of the display. The time base selected is shown in the second line of the top display.

SETUP

Now press this key to save the setup in memory.

Learning Scope Mode



This key accesses the Setup Save Pop-Up Menu.



Press this key to highlight Setup 2.



Press this key to store this setup in the Setup 2 memory.



Press this key to access the Waveform Softkey Menu. You will now press a sequence of keys to copy the channel A waveform to a memory location, in this case Temp 1.



Access the Copy From Pop-Up Menu.



Highlight Channel A and ENTER your choice. The Copy To Pop-Up Menu now appears.



Highlight Temp. 1 and ENTER your choice. The waveform is now stored and can later be recalled to the display.





Turn ScopeMeter OFF.

Learning Scope Mode



OPERATING CONFIGURATION

ScopeMeter always retains the configuration that you set up using the keypad. While ScopeMeter is operating, this configuration can only be changed through meaningful key presses. If ScopeMeter is not operating (power pressed OFF with  or due to a timeout during battery operation), the operating configuration previously in effect is restored when  is pressed ON. This setup retention can be very useful, especially if you are performing repeated similar measurements.

ScopeMeter also provides you with the following useful shortcuts for recovering a specific setup configuration:

- **AUTO SET** 

AUTO SET usually optimizes the range in Meter Mode or the time base and amplitude in Scope Mode. Often, you will only need to press  to obtain a meaningful display.



- **MASTER RESET**

You can restore factory default settings with a master reset. However, this procedure must be performed with some caution: all stored setups and waveforms are erased with a master reset. Refer to Section 4 for a further discussion of the master reset procedure and the resulting ScopeMeter configuration.

- **SETUP MEMORIES** 

You can store up to 10 front panel setups in ScopeMeter's memory. Later, you can set up ScopeMeter automatically for a specific type of test by recalling the appropriate memory. Setup Memories are discussed later in this section.

UNDO

Press  to cancel the last use of any other key. ScopeMeter reverts to the previous display. Continue pressing  to step back through preceding key/display configurations; you can step back 10 times in this fashion.

The Undo feature operates in a loop. If you want to step forward again, just continue pressing ; after 10 steps back, ScopeMeter begins stepping forward. Note that related pop-up menus are not displayed as you move sequentially through the steps.

SETUP MEMORY

You can avoid repeating your keystrokes by storing the ScopeMeter setup in memory. (A setup is simply the operating configuration at the moment.) You can save a maximum of 10 ScopeMeter setups in this fashion. As soon as you feel comfortable with ScopeMeter, you may want to keep a separate record of what each stored setup can do.

1. Press **SETUP**. The Setup Softkey Menu appears. If a setup has already been stored, the first menu shown is displayed. If no setup has been stored, the second menu is displayed.

NOTE

If no setup memory is active, press **SOFTKEY 2**, then press **▼** **▲** to highlight one of the memories. Press **SOFTKEY 5** to store the present ScopeMeter setup.

2. Use the Setup Softkey Menu keys as follows. For each type of selection, step through the active items with **▲** and **▼**. Activate a selection by pressing **SOFTKEY 5** (ENTER).

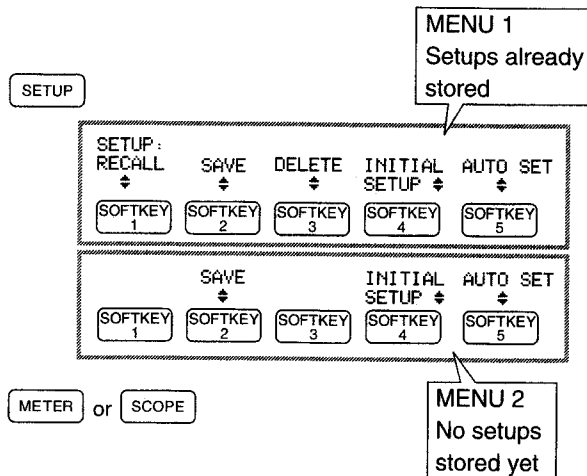

Setup Softkey Menu



- Press **SOFTKEY 2** (SAVE) to save a setup into setup memory (Setup 1 through Setup 10).

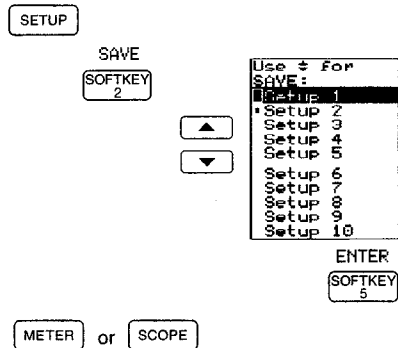

Setup Save Pop-Up Menu

- Press **SOFTKEY 1** (RECALL) to recall a saved setup from setup memory (Setup 1 through Setup 10). The Right Display keeps track of the recalled setup by memory number (just below ↕RECALL in the Right Display.)

While ↕RECALL is displayed, you can also quickly rotate through the setups using .

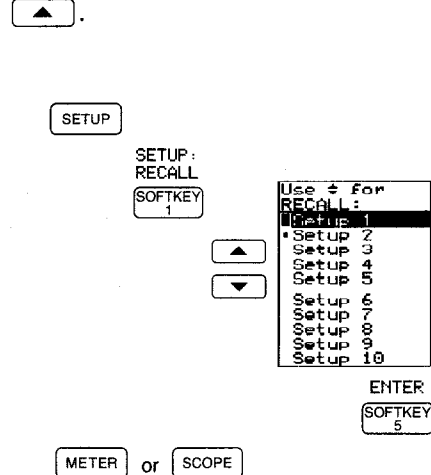

Setup Recall Pop-Up Menu

- Press **SOFTKEY 3** (DELETE) to delete a saved setup from setup memory (Setup 1 through Setup 10).

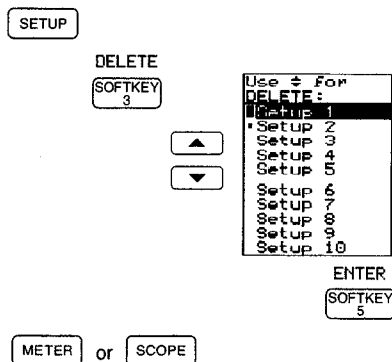

Setup Delete Pop-Up Menu

- Press **SOFTKEY 4** (INITIAL SETUP) to select initial setup items. These items will be used when the ScopeMeter is powered ON. A master reset destroys these selected items and leaves initial setup with its default settings. Refer to Section 4 for a complete discussion of Initial Setup.
- Press **SOFTKEY 5** (AUTOSET) to select items that the AUTOSET feature will influence. A subsequent master reset destroys the new selected items and leaves AUTOSET with its factory default settings. Refer to Section 4 for more information.

Section 2

Using the Meter

Contents

IN GENERAL	2-2	DISPLAY MODES	2-10
METER MODE CONNECTIONS	2-3	Frequency	2-11
FUNCTIONS AND RANGES	2-4	Duty Cycle \pm	2-11
Vrms AC	2-5	Trace Disp.	2-11
Input Coupling	2-5	%Delta	2-12
V DC	2-6	Scaling	2-12
mV DC	2-6	Volt Math	2-12
Diode Test	2-7	ALERT	2-12
Resistance	2-8	ZERO	2-12
Manual Range	2-9	FAST/SMOOTH	2-12
Auto Range	2-10	TOUCH HOLD®	2-13
TRACE DISPLAY IN METER MODE	2-10	DISPLAY HOLD	2-13
		METER RECORD	2-13
		OVERLOAD INDICATIONS	2-15

IN GENERAL

Press **METER** to access the Meter Function Softkey Menu. Meter Mode starts in the function last selected. You can then choose a different function by pressing one of the softkeys. Choose Vrms AC + DC by pressing **METER** a second time.

The Meter Mode display is shown in Figure 2-1.

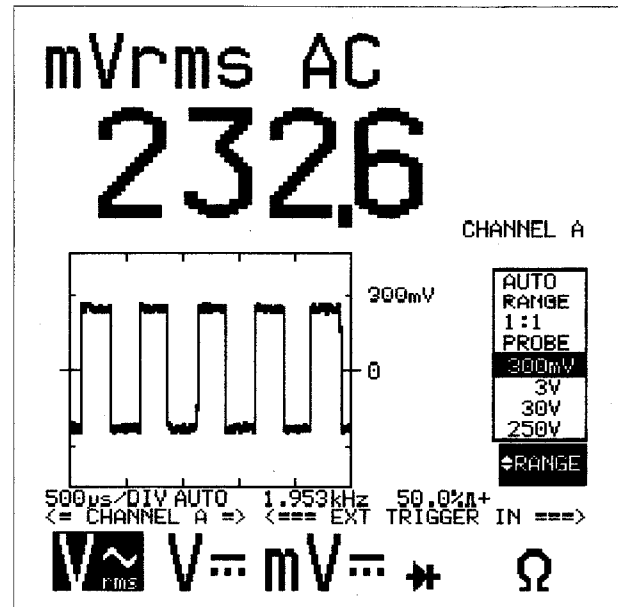

Figure 2-1. Meter Mode

METER MODE CONNECTIONS

Measurement connections for the Meter Mode functions are shown in Figure 2-2.

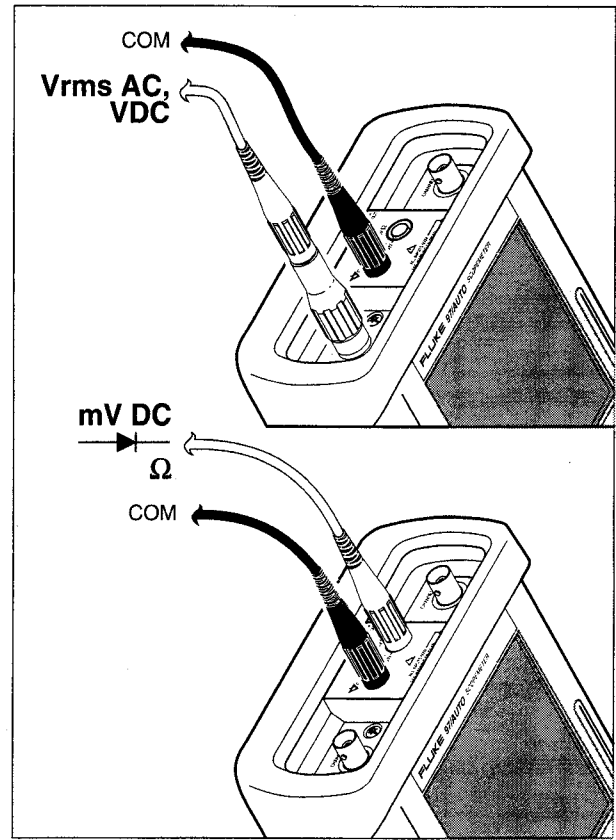



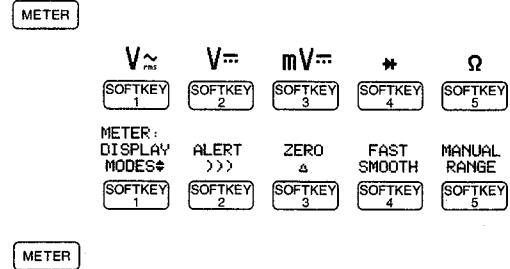

Figure 2-2. Meter Connections

FUNCTIONS AND RANGES

From the Meter Mode Softkey Menu, press a softkey to select a measurement function. Once a meter function is selected, the softkeys change definition to become the Meter Function Softkey Menu. The measurement can be displayed as both a digital display and a scope trace. In manual ranging, the ranges are selected with  and  or with  and . Available ranges and the highlighted selected range are shown on the right side of the display.



Meter Softkey Menus

Vrms AC SOFTKEY
1

Channel A is used for the input to measure Vrms AC signals, resulting in a 3000-count meter display or a combined display with meter digits and a scope trace. You can also make a selection between ac and dc input coupling. A typical Vrms AC display is shown in Figure 2-3.

Input Coupling

Press AC DC
GROUND to select the type of input coupling for channel A. When the display shows Vrms AC, an ac-coupled input is selected. When the display shows Vrms AC+DC, dc-coupled input is selected.

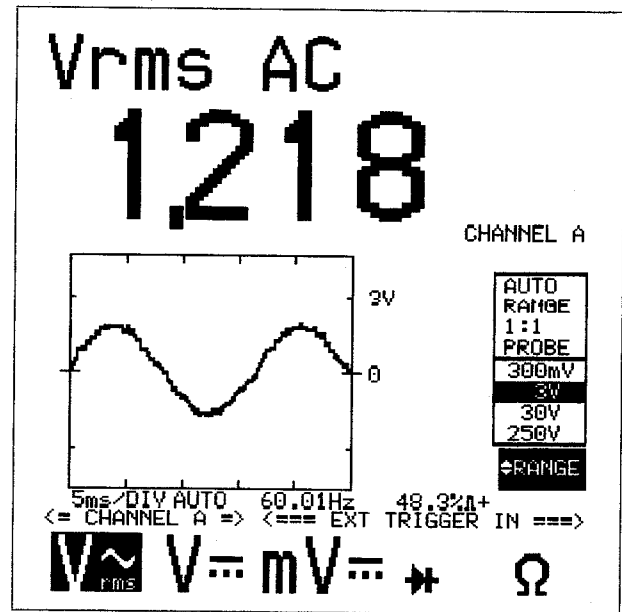

Figure 2-3. Vrms AC Display

V DC SOFTKEY
2

Channel A is used for the input to measure V DC signals, resulting in a 3000-count meter display or a combined display with meter digits and a scope trace. A typical V DC display is shown in Figure 2-4.

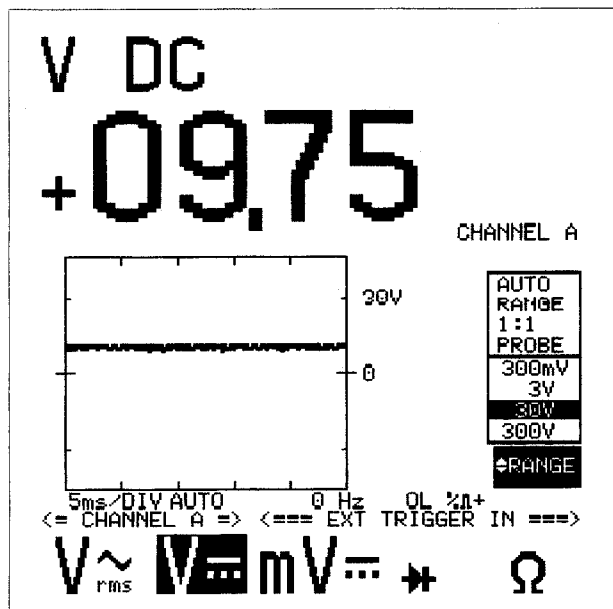

Figure 2-4. V DC Display

mV DC SOFTKEY
3

The mV Ω and COM banana jack inputs are used to measure mV DC signals, resulting in a 3000-count meter display or a combined display with meter digits and a scope trace. The ranges are 300 mV and 3V. A mV DC display is shown in Figure 2-5.

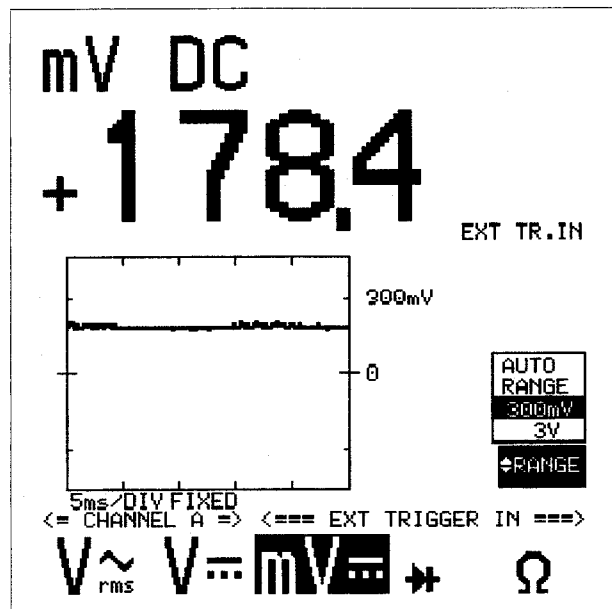

Figure 2-5. mV DC Display

Diode Test SOFTKEY
4

The **mV** Ω \leftrightarrow and COM banana jack inputs are used to test a diode, resulting in a 3000-count meter display or a combined display with meter digits and a scope trace. The measurement current through the diode is 0.5 mA. The result is displayed as the forward or reverse voltage bias of the diode.

Once you have selected diode test, you can select ALERT by pressing SOFTKEY
2. ScopeMeter now provides an audible beep for each diode test that passes. A diode test display is shown in Figure 2-6.

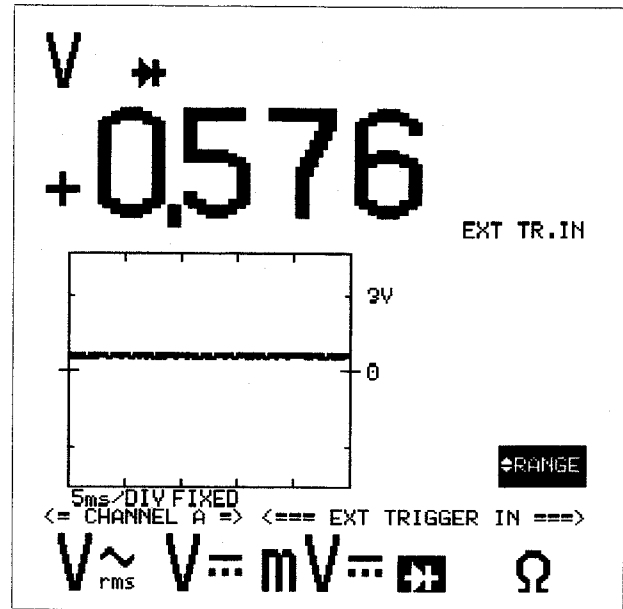

Figure 2-6. Diode Test Display

Resistance SOFTKEY
5

A resistor connected to the **mV Ω** and COM banana jack inputs will be measured. The RED banana socket is the high input and the BLACK one is the low input.

NOTE

*In the **Ω** and **Ω** functions, the black COM banana jack is not connected internally to the common of the scope BNC inputs of channel A and B.*

The measurement result is displayed as a 3000-count display and a scope trace display. The ranges are 30Ω, 300Ω, 3 kΩ, 30 kΩ, 300 kΩ, 3 MΩ and 30 MΩ. The 30Ω range cannot be selected with Auto Range; you must press ▲ or mV to select 30Ω (and select Manual Range).

A beeper warning is generated at <5% of a selected range in manual ranging. A beeper warning is turned on with ALERT))) in the Meter Display Modes Pop-Up Menu. A resistance measurement display is shown in Figure 2-7.

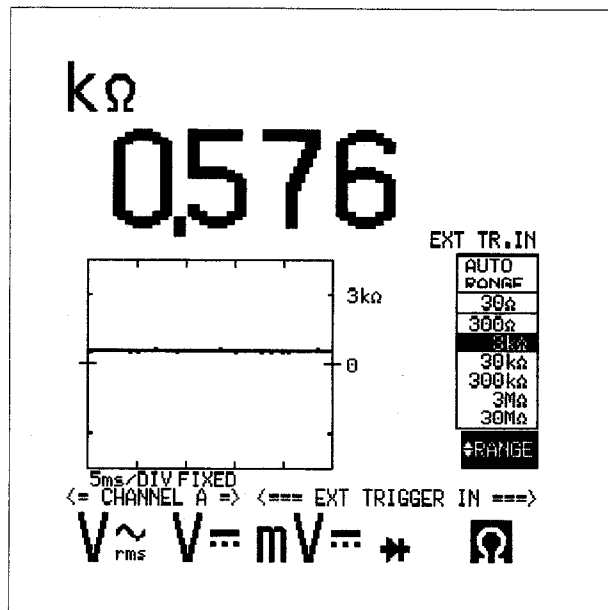

Figure 2-7. Resistance Measurement Display

Manual Range

From the Meter Mode Softkey Menu, you can select manual ranging by pressing **[SOFTKEY 5] AUTO RANGE** or **[▲] [▼]**. The ScopeMeter input attenuator range can now be changed by pressing **[▲] [▼]**.

You can also press **[v]** or **[mv]** for channel A to change the range at any time. If ScopeMeter is in Auto Ranging, making a valid range change with **[v]** or **[mv]** also automatically selects Manual Ranging.

Select the desired time base by pressing **[s TIME ns]**. In V_{\sim} and V , you can select time bases from 1 μ s to 100 ms per division. In mV , $*$, and Ω , the time base is fixed at 5 ms per division.



Ranges available for each function are shown in Figure 2-8.

V_{\sim}	AUTO RANGE 1:1 PROBE 300mV 3V 30V 250V ↕RANGE	AUTO RANGE 10:1 PROBE 300mV 3V 30V 2.5kV ↕RANGE	AUTO RANGE 100:1 PROBE 300mV 300V 3kV 25kV ↕RANGE	AUTO RANGE 1000:1 PROBE 300V 3kV 30kV 250kV ↕RANGE
$V_{=}$	AUTO RANGE 1:1 PROBE 300mV 3V 30V 300V ↕RANGE	AUTO RANGE 10:1 PROBE 3V 30V 300V 3kV ↕RANGE	AUTO RANGE 100:1 PROBE 30V 300V 3kV 30kV ↕RANGE	AUTO RANGE 1000:1 PROBE 300V 3kV 3kV 300kV ↕RANGE
$mV_{=}$	300mV 30V ↕RANGE			
$*$	(NA)			
Ω	AUTO RANGE 30 Ω 300 Ω 3k Ω 30k Ω 300k Ω 3M Ω 30M Ω ↕RANGE			

Figure 2-8. Meter Ranges

Auto Range

Auto ranging (automatic setting of the voltage level attenuator) is selected when any of the following actions occur:

-  is pressed. This action automatically selects a voltage level attenuation and time base suitable for a meaningful display. It leaves ScopeMeter in AUTO RANGE.
-  is pressed for AUTO RANGE.
- A new meter function is selected. Both auto attenuation and auto time base are selected.

NOTE

*In the mV and Ω functions, the time base range is fixed at 5ms/DIV. In the * function, the time base range is fixed at 5ms/DIV and the attenuator range is fixed at 3V.*

TRACE DISPLAY IN METER MODE







ScopeMeter automatically shows a scope trace starting at the first detected trigger. The trace appears below the digital readout and spans five time divisions.

In the V_{\sim} , V, and V_{rms} AC + V DC functions, the time base of the scope trace and the attenuator range of both the scope trace and meter display result can be selected.

The time base is expressed as time/division. If the trace is not displayed, the expression time/division is used to give an indication for the time base of the system.

NOTE

One acquisition is 20 divisions. Five divisions are automatically displayed.

Press  to set the selected function to manual or automatic ranging of the time base and attenuator, if possible. In Diode Test (*), manual ranging is not possible. The attenuator range area in the display shows the ranges possible and the type of ranging. Press  and  to select the attenuator ranges. ScopeMeter automatically switches to manual ranging if  or  is pressed. Press  to select the time base ranges.

DISPLAY MODES

Once you have selected a specific meter function and range, the Display Modes Pop-Up Menu can be accessed by pressing . Although the display is frozen when the pop-up menu is turned on, signal acquisition continues.

NOTE

The Display Modes Pop-Up Menu winks out after about 30 seconds if no activity is detected. Just press **SOFTKEY 1** again.

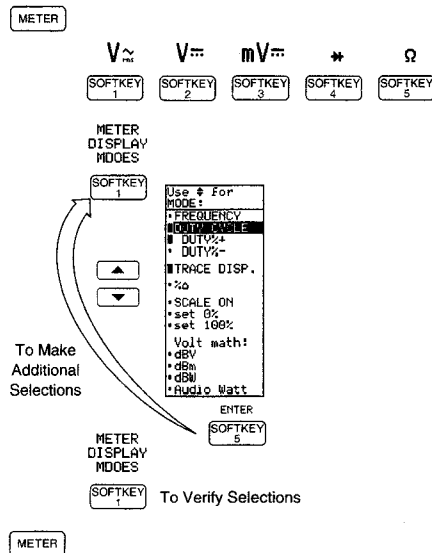
**Meter Display Modes Pop-Up Menu****Frequency**

When FREQUENCY is selected, the meter voltage display is replaced by the meter frequency display. The frequency of the input signal can be measured in Vrms AC, Vrms AC + DC and V DC functions.

Duty Cycle \pm

Select DUTY CYCLE to display the relative on-to-off time of a varying input signal. The main display then shows a percentage figure. You must select DUTY%+ or DUTY%- to display the duty cycle of the input above or below the fixed reference level, respectively.

Duty cycle can easily be converted to degrees of dwell in automotive measurements by using the table found in Appendix 8F of this manual.

Trace Disp.

Select TRACE DISP. to turn the trace display on during Meter Mode measurements. DC signal levels and ac voltage variations are then displayed simultaneously below the digital readout. TRACE DISP. is the default selection when a measurement function is first selected.

%Delta

Percentage change (delta, - the difference between) uses the present reading as a relative reference. The display then shows a percentage that represents how far the present reading is from this reference. This selection is described more fully in Section 4.

Scaling

Scaling displays the present measurement result with respect to a range defined with 0% and 100% values. Entering the 0% and 100% values automatically selects SCALE ON. Refer to Section 4 for more information.

Volt Math

Use one of the Volt math: selections to display the measurement in dBV (decibel Volts), dBm (decibel milliwatt), dBW (decibel Watt), or Audio Watt. Refer to Section 4 for more information.

ALERT

From the Meter Function Softkey Menu, press  ALERT to set up ScopeMeter to warn you with a beep when the measurement changes more than 100 digits. In resistance testing (Ω), ALERT beeps when the measurement falls to less than 5% of the measuring range; this feature provides an audible feedback for continuity testing. In diode testing (\ast), the beep signifies a good diode test.

ZERO

From the Meter Function Softkey Menu, press  to establish the existing reading as a zero reference point. Subsequent displays then show only the difference between the latest reading and the stored value. This feature is useful when you need to monitor input activity in relation to a known good value. ZERO can also be used with dBV, dBm, dBW or Audio Watts.

FAST/SMOOTH

From the Meter Function Softkey Menu, you can select the rate at which the display is updated (refreshed.) Some types of measurements will be easier to interpret if the refresh rate is increased or slowed down. Speed up the rate by selecting (highlighting) FAST. A fast rate is useful when you are making adjustments and must see the resulting reading as quickly as possible.

Select SMOOTH to average readings over the last six seconds. This selection reduces the influence of noise or unstable input signals.

Make no selection (FAST and SMOOTH not highlighted) for normal measurements.

TOUCH HOLD®

Touch Hold captures the next consecutive stable measurement result. A beep indicates that a stable result has been captured. When first enabled, the numeric display is frozen (held) until a stable result is detected. Stable results are defined as within ± 100 display counts for 1s and above a floor of 200 display counts in VDC and mVDC, above 300 display counts in VAC, and below overload (OL) in Ω and diode test.

The following procedure can be used with V_{rms} AC + V DC, V_{\sim} , V, mV, \ast , or Ω :

NOTE

HLD is displayed in non-reverse characters when Touch Hold is active.

1. Press **HOLD RUN** and measure the signal.
2. Wait until the meter produces a beeper signal to indicate a stable signal.
3. Remove the measuring leads and read the result from the display.
4. Measure a new signal, wait for the beeper, remove the leads, and read again.

®Touch Hold is a registered trademark of the John Fluke Mfg. Co., Inc.

NOTE

Touch Hold is not available with the FREQUENCY display mode, SMOOTH feature, or Meter Record mode. HLD is displayed in reverse characters in these instances.

DISPLAY HOLD

Unlike Touch Hold, which waits for a stable input signal, Display Hold can be used at any time to immediately freeze the displayed reading. This feature offers you time to view a sample of a changing reading or to capture a reading of interest.

Press **HOLD RUN** to activate Display Hold; HLD appears in the display. Press **HOLD RUN** a second time to resume display updates. You can repeat this procedure as often as you want.

METER RECORD

In Meter Record Mode, ScopeMeter records the maximum (MAX), average (AVG), minimum (MIN) readings while continuing to display the present reading (NOW). Turn on Meter Record by pressing **RECORD** from Meter Mode. See Figure 2-9. Turn Meter Record off by selecting a new meter function, by pressing **RECORD** a second time, or by pressing **AUTO SET**. The auto shutdown feature is defeated in Meter Record Mode; ScopeMeter will stay on even if a low battery condition is detected.

NOTE

A beep occurs when a new MAX or MIN value is detected. New MIN, MAX, and AVG readings are then updated on the display.

Time stamps appear next to the MAX, AVG, and MIN readings in Meter Record Mode. These figures show the elapsed time in hours, minutes, and seconds since Meter Record activation to the most recent change in the respective reading. The AVG time stamp updates continuously. The MAX and MIN time stamps update only as new high or low readings are encountered.

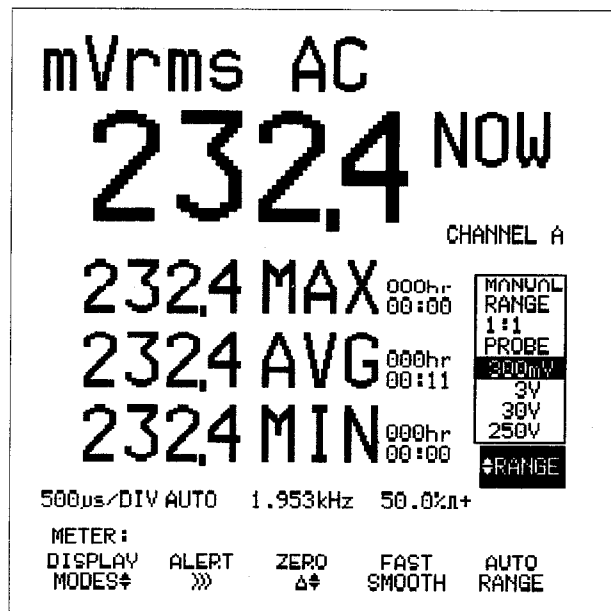







Figure 2-9. Meter Record Mode

OVERLOAD INDICATIONS

If an input is too high for the function and range, **OL** is displayed. As long as the maximum input ratings for the instrument have not been exceeded, ScopeMeter will not be harmed. ScopeMeter is electronically protected from overload conditions; no fuse replacement is necessary.

You can correct an overload situation with any of the following procedures:

- Select an appropriate function and range.
- Make your measurement with a different probe. Remember, you must also select the probe type for Channel A from the Probe Cal Pop-Up Menu. If necessary, press   to access this menu. Press   to highlight your selection for Channel A, then press  to activate this selection.
- Lower the input level.

Section 3

Using the Scope

Contents

IN GENERAL.....	3-2	ADJUSTING THE AMPLITUDE.....	3-13
Types of Waveforms.....	3-2	AUTOSET	3-14
Terminology.....	3-4	POSITIONING THE WAVEFORM ON THE	
MAKING CONNECTIONS.....	3-4	DISPLAY.....	3-15
WAVEFORM ACQUISITION.....	3-5	CHANNEL SELECTION.....	3-16
Recurrent.....	3-5	AVERAGING.....	3-17
Single.....	3-5	DISPLAYING MULTIPLE WAVEFORMS.....	3-18
Roll Mode.....	3-7	SCOPE RECORD MODE (MIN/MAX on A) ..	3-19
SELECTING THE TRIGGER.....	3-7	WAVEFORM QUICK STORAGE.....	3-19
Trigger Basics.....	3-7	USING THE CURSOR	3-19
Trigger Source.....	3-10	Cursor Source	3-20
Trigger Slope.....	3-11	Cursor Function	3-20
Trigger Level.....	3-11	Scrolling	3-22
Trigger Delay.....	3-11	Markers.....	3-22
TRIGGER at 50%.....	3-12	Cursor Positioning.....	3-23
INPUT COUPLING.....	3-12	MORE INFORMATION	3-23
ADJUSTING THE TIME BASE.....	3-13	HELP	3-24

IN GENERAL

This section introduces you to the real power of ScopeMeter: displaying and analyzing complex waveforms. You will see how amplitude, time base, trigger, and signal coupling are set to display waveforms for Channels A and B. You will also learn to use ScopeMeter's cursors to tell you everything you need know about the signal being measured.

Press **SCOPE** to access the Scope Function Softkey Menu. Scope Mode starts in the configuration last selected. A typical Scope Mode display is shown in Figure 3-1.

Types of Waveforms

ScopeMeter can display virtually any type of waveform. Each type exhibits a characteristic shape, usually resulting in the name commonly used for that type. In Scope Mode, you will encounter waveform patterns that will usually look like one of the examples in Figure 3-2.

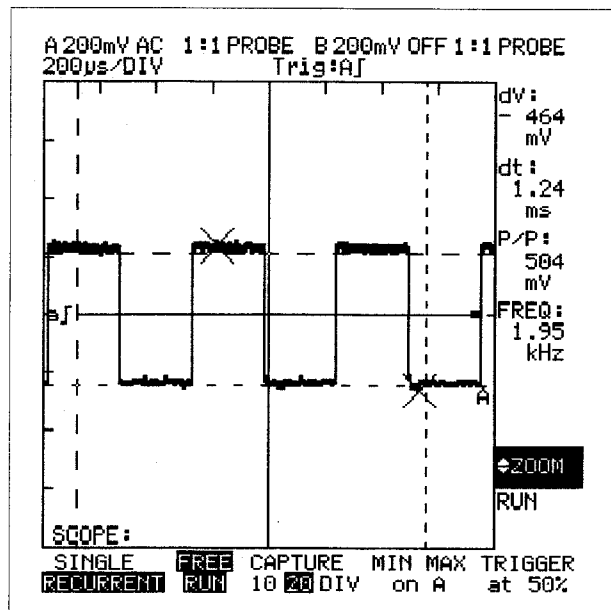

Figure 3-1. Scope Mode

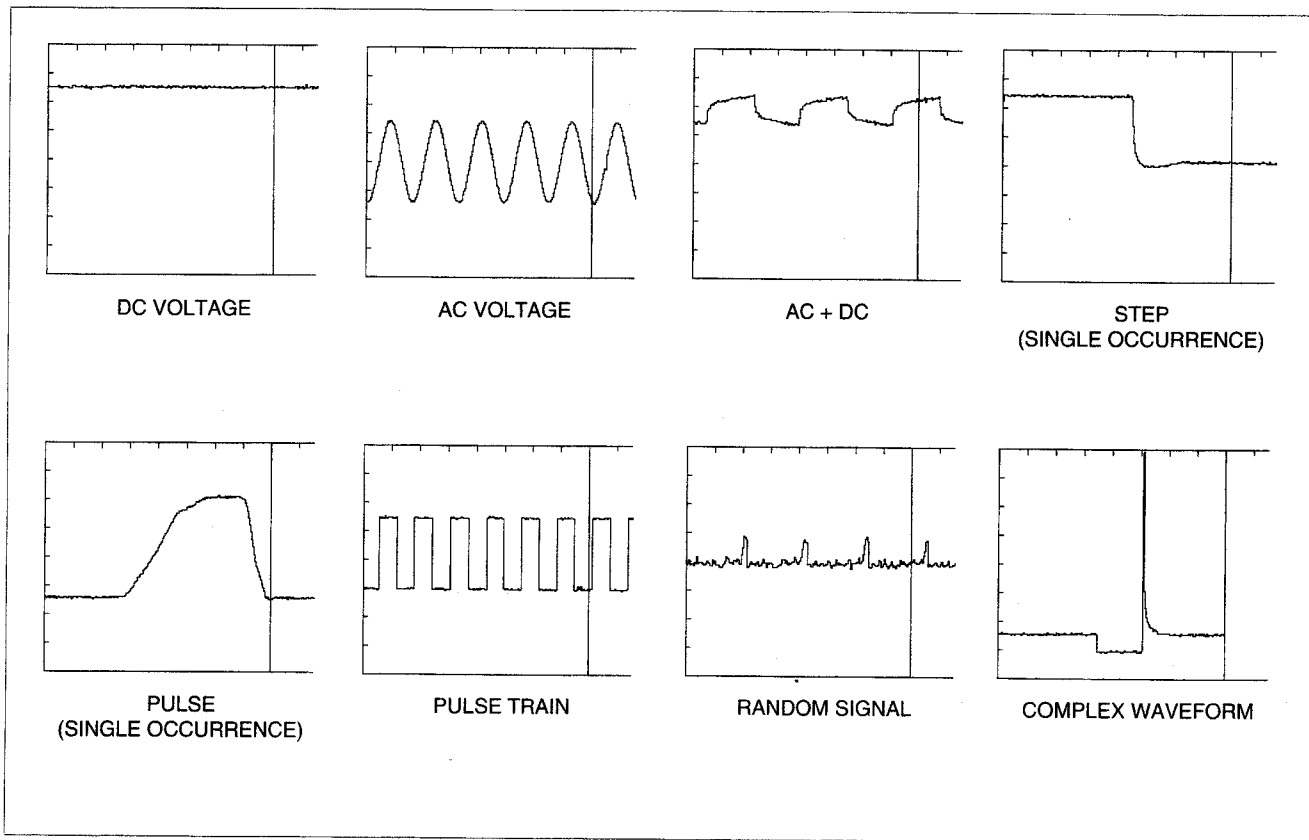

Figure 3-2. Common Waveform Types

Terminology

Many terms that are specific to oscilloscope operation are used in this section. If you want additional explanation for any of these terms, consult Section 8, Appendix D, Terminology.

MAKING CONNECTIONS

Scope Mode connections are illustrated in Figure 3-3.

⚠ Maximum scope inputs on either channel are as follows:

- Maximum input signal voltage: 300V rms
- Voltage to ground: 600V rms

Input impedance (direct) is 1 M Ω /25 pF with the 1:1 probe or 10 M Ω /15 pF with the 10:1 probe.

Input coupling is selectable (AC, DC, Ground).

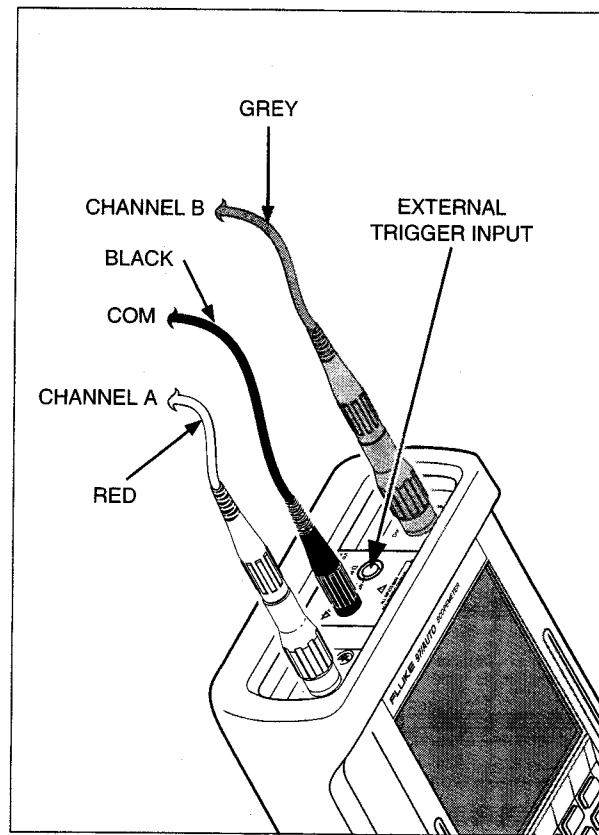

Figure 3-3. Scope Mode Connections



WAVEFORM ACQUISITION

You can instruct ScopeMeter to continuously update its display, giving you a dynamic look at waveform activity as it occurs (RECURRENT.) You can also tell ScopeMeter to update its display only once, yielding a snapshot record of waveform activity (SINGLE, termed “Single Shot” elsewhere in this manual.)

Recurrent

Press **SOFTKEY 1** to highlight this selection for continuous display updates as triggers are detected. Pressing **HOLD RUN** stops and starts an acquisition. A flashing HOLD on the display indicates that acquisition is stopped. The time base range is $5s/DIV$ to $10ns/DIV$.

Single

Set up ScopeMeter for “Single Shot” acquisitions with the following procedure:

1. Press **SOFTKEY 2** to turn FREE RUN off (not highlighted).
2. Press **SOFTKEY 1** to highlight SINGLE. “HOLD” begins flashing in the lower right display.
3. Press **HOLD RUN**. “NO TRIG” begins flashing in the lower right display. ScopeMeter is waiting for a trigger.

4. “RUN” appears on the screen when the single acquisition is triggered. “HOLD” then reappears.
5. Now press **HOLD RUN** again and wait for another single acquisition trigger.

The time base range is $5s/DIV$ to $100ns/DIV$.

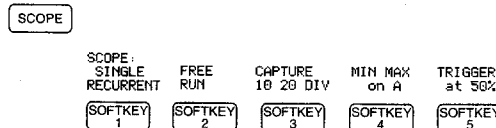

Scope Softkey Menu

Waveform acquisition relies on a valid trigger source being available. Triggering is fully discussed later in this section. The Scope Softkey Menu normally shows FREE RUN on (highlighted); if no trigger is detected for 100 ms, ScopeMeter resets and restarts an acquisition, providing its own trigger. You can deactivate FREE RUN by pressing **SOFTKEY 2**.

NOTE

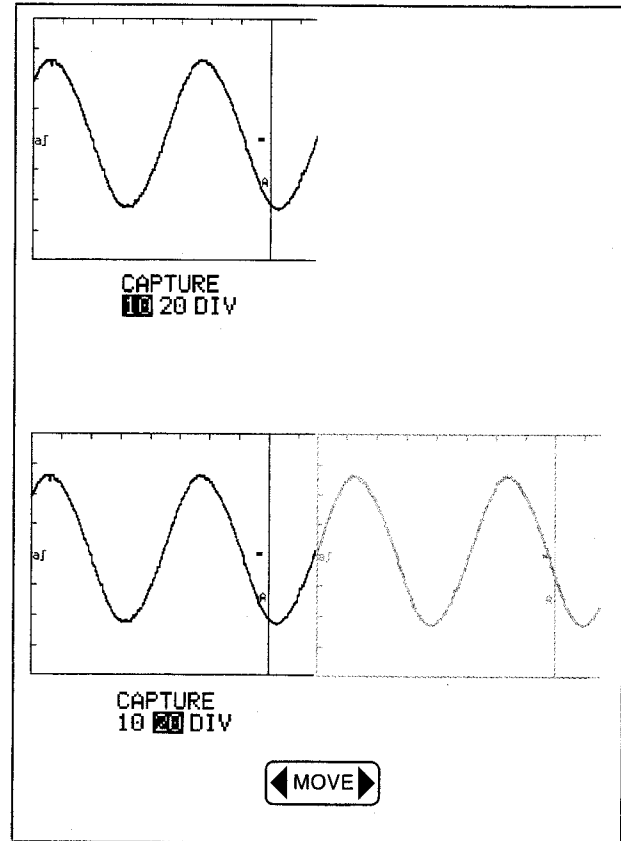

NOTRIG flashing in the Right Display indicates that ScopeMeter is ready and waiting for a trigger signal.

You can use **◀MOVE▶** to scroll the acquired waveform back and forth across the display. Display width is either 9-1/2 time divisions (cursors off) or 8 time divisions (cursors on, occupying 1-1/2 time divisions in the Right Display area.)





Waveform Capture



If 20 is selected with , additional waveform activity occurs off the display for each acquisition. The scrolling capability allows you to examine this off-display activity. Pressing  allows you to CAPTURE waveform activity over 10 or 20 time divisions for examination in this fashion. Usually, you will want to use 10 divisions for low frequency signals. Use 20 divisions for high-frequency signals.

Roll Mode

Roll Mode supplies a visual log of waveform activity and is especially useful when measuring lower frequency signals. To enter Roll Mode, press  from the Scope Mode Softkey Menu to select RECURRENT, then press  to select 10s/DIV ROLL, 20s/DIV ROLL, or 60s/DIV ROLL.

The waveform is now slowly traced on the display from left to right. The Roll Mode is automatically turned off if a time base 5s/DIV or faster is selected.

Roll is an untriggered mode. The CAPTURE 10 20 DIV, TRIGGER at 50%, and FREE RUN softkey selections are not available. However, the waveform can be frozen on the display by pressing .

SELECTING THE TRIGGER

Trigger Basics

Triggering adds another dimension; it tells ScopeMeter when to begin displaying the waveform. You can set the trigger signal level to a minimum that must be exceeded and select a signal direction (slope) that must be followed before crossing that level. You can also specify another source for triggering the display; this means that a second synchronizing signal must be present before the waveform can be displayed. Finally, you can tell ScopeMeter to delay its display update until after a specified time delay, number of cycles, or number of events has occurred. Refer to Figure 3-4.

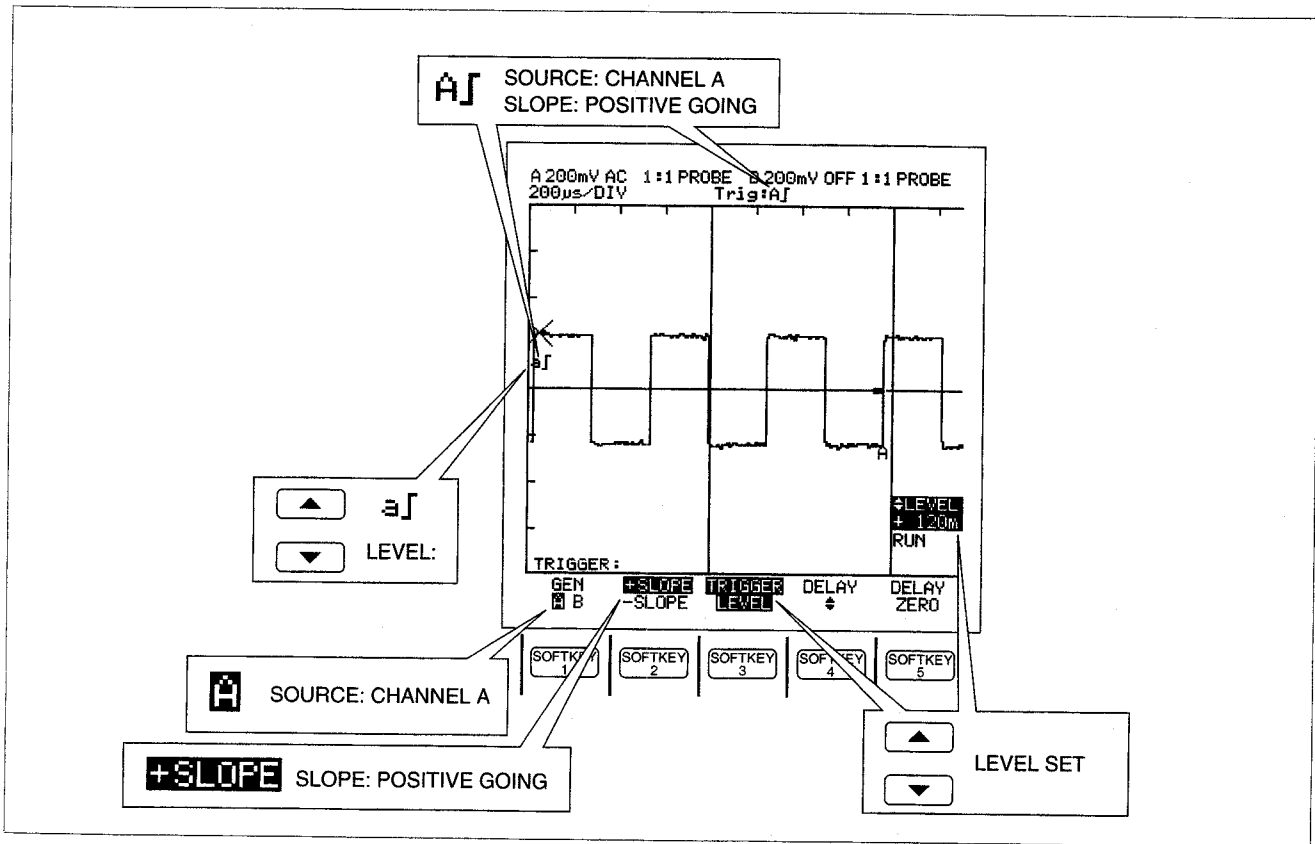

Figure 3-4a. Trigger Settings

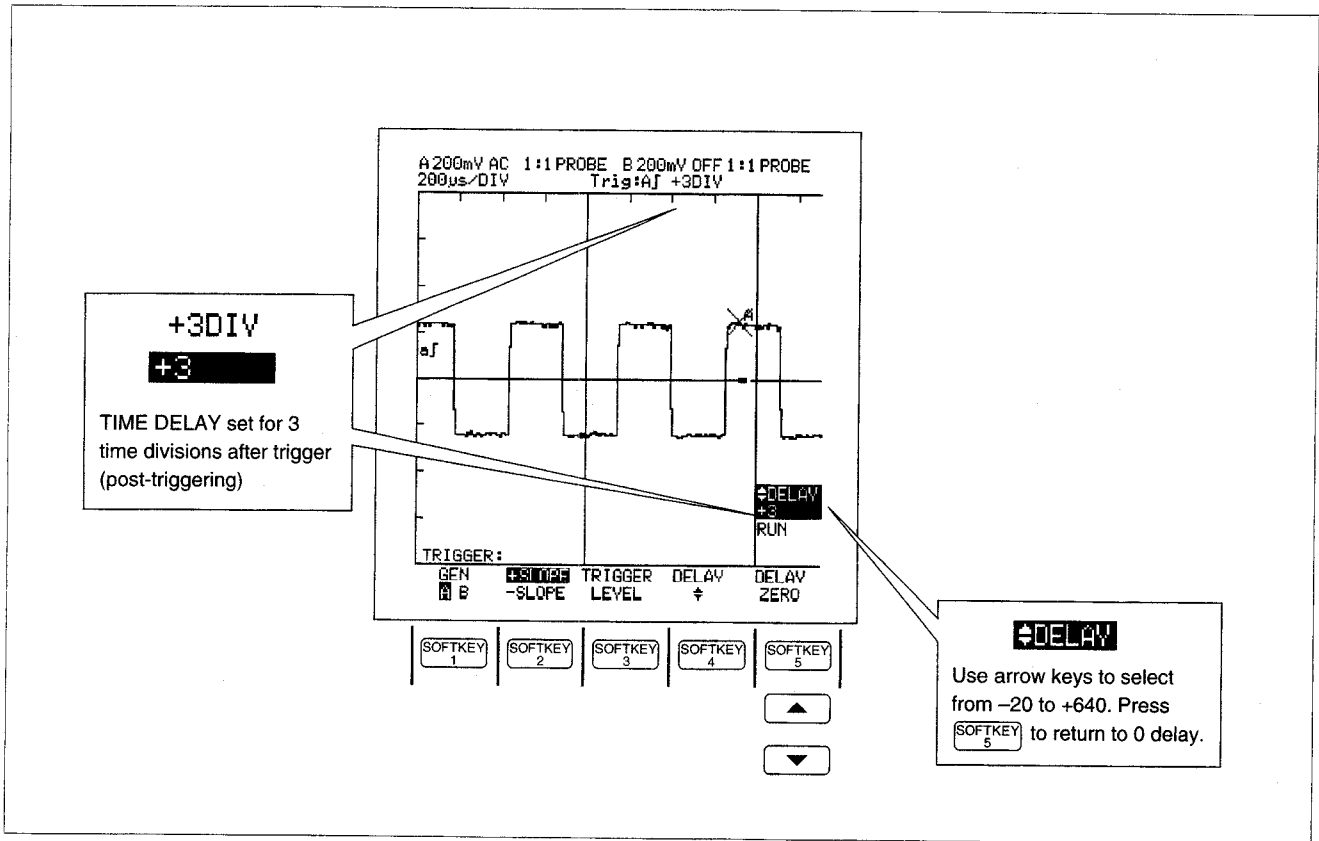
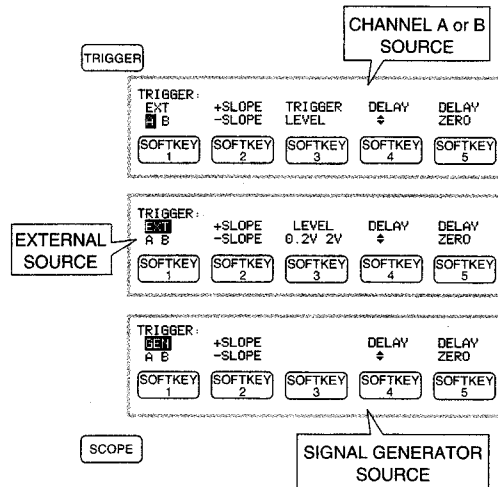

Figure 3-4b. Trigger Delay

Why would you want to do this? When you are looking at a single predictable waveform, triggering may not be an important concept. But, with complex systems, triggering allows you to be very selective in telling ScopeMeter what to display; the displayed waveform(s) can, therefore, be much more meaningful. Some general uses are as follows:

- Often, a signal must exceed a certain level to be usable by an electrical or electronic circuit. If you set that level as a triggering precondition, only known-good signals will be displayed.
- Electronic components are often controlled by a voltage that must be increasing (positive-going) or decreasing (negative-going). For example, one level may need to be exceeded to activate a device (signal positive-going), while yet another level would need to be crossed to deactivate the device (signal negative-going.) ScopeMeter allows you to specify triggering on +SLOPE or -SLOPE.
- Some waveforms occur only when some other signal is present. Using one signal as a triggering source for another verifies this cause-effect relationship. ScopeMeter allows you to specify the trigger source as Channel A, Channel B, the built-in Signal Generator, or an external signal.

ScopeMeter triggering characteristics are set through the Trigger Softkey Menu (press **TRIGGER**).



Trigger Softkey Menus

Trigger Source

Press **SOFTKEY 1** to select trigger source A (via channel A), B (via channel B), GEN (via internal signal generator) or EXT (via external trigger input).



GEN appears only if the generator has been turned on. To turn the generator on, press **SPECIAL FUNCT** **SOFTKEY 1** to access the Generator Pop-Up Menu. Then press **▲** **▼** (to highlight 1.95kHz, 976Hz, 400Hz, or SINE WAVE), followed by **SOFTKEY 1** (ENTER) to activate the selection.

EXT is available as a trigger source selection when the generator is off. Press **SOFTKEY 3** (LEVEL 0.2V 2V) to highlight the appropriate TTL-compatible (Transistor to Transistor Logic) trigger level (0.2V or 2V).

An external trigger can be connected at the Red banana jack. The maximum input signal voltage is 300V rms, and the maximum voltage to ground is 600V rms. External trigger input impedance is 1 M Ω /25 pF.

Trigger Slope

Press **SOFTKEY 2** to select triggering on the +SLOPE or -SLOPE.

Trigger Level

Press **TRIGGER** to access trigger level adjustment. If channel A or B is selected as the trigger source, **LEVEL** appears in the Right Display area, and you can use **▲** and **▼** to adjust the trigger level in 4% increments of the attenuator range. Observe

the level changes in the Right Display, just below **LEVEL**. For example, if the 1V range is selected, press **▲** and **▼** to change the level in 40 mV steps.





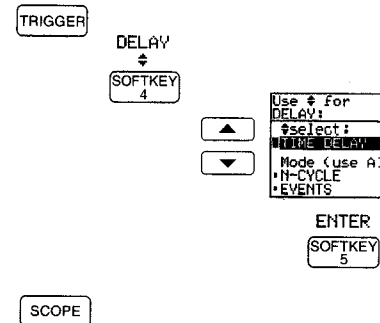

Trigger Delay

You can also tell ScopeMeter to begin displaying the waveform at some time before or after the trigger is received. From the Trigger Softkey Menu, press **SOFTKEY 4** to enter the Trigger Delay Pop-Up Menu. You can now select the trigger delay.



Trigger Delay Pop-Up Menu

Types of trigger delays are discussed below. In many instances, you can select more than one type of delay.

- **TIME DELAY** \leftrightarrow **DELAY** appears in the Right Display. You can now press  or  to set the trigger time delay in increments of the existing time base divisions. The range of divisions is -20 to +640. For example, if the time base is set to 2ms/DIV, +16 defines a delay of 16 time divisions (32 milliseconds.)
- **N-CYCLE** The trigger signal is divided by N to create a stable picture for signals with a cyclic character. (N-CYCLE can be used only on Channel A.) Select the N-CYCLE number by pressing  and . A total of +2 to +255 cycles can be selected. For example, you can use 6-CYCLE to measure ignition pulses of an 6-cylinder engine.
- **EVENTS** Triggering via the external trigger input can be delayed for a number of events. The event is the trigger condition for channel A. Select the number of events by pressing  and . For example, primary and secondary ignition patterns can be viewed using the RPM80 Inductive Pickup as an external trigger input.
- **DELAY ZERO** Press . All the selected trigger delays are reset to their initial values (TIME DELAY +0, N-CYCLE 2, EVENTS 1.)

TRIGGER at 50%

From the Scope Softkey Menu, press  to set the trigger level at 50% of the input signal voltage. The active input trigger source is used as the reference. For example, if channel A has been selected, ScopeMeter automatically triggers at 50% of the peak-to-peak value, as observed on the display.

INPUT COUPLING

Press  for the appropriate channel to select the input signal coupling. The selection is shown in the upper line of the Top Display. AC coupling allows for reading ac voltages only. DC coupling allows for reading ac and dc voltages.

The GROUND selection disconnects the input signal, displaying only the ground level as a horizontal line. GND provides a useful tool for setting up the display to show a high dc level or voltage spike. For example, if you anticipate a high positive dc level, select GROUND and press  to move the ground level lower on the display. You may want to position the ground level on one of the voltage division marks (left side of display) for a precise reference point. Then reconnect the input signal by selecting AC or DC. A small marker box on the right side of the display identifies the ground level.



ADJUSTING THE TIME BASE

Press **s TIME ns** to change the time base, as defined on the Upper Row of the Top Display. Refer to Figure 3-5. Available settings depend on the acquisition mode in effect, as follows:

- Recurrent 10ns/DIV - 5s/DIV
- Single 100ns/DIV - 5s/DIV
- Roll 10s/DIV - 60s/DIV

For each trigger mode, the time base can be changed in increments of 1, 2, and 5 (e.g., 10 ns, 20 ns, 50 ns).

ADJUSTING THE AMPLITUDE

You can use **v** **mv** for channel A or B to adjust input signal attenuation. Sixteen ranges are available. However, to optimize the displayed signal, the 16 ranges vary according to the type of probe in use. A 1:1 probe can accommodate a maximum of 100V ac per division, while a 10:1 probe can accommodate a maximum of 1 kV ac per division. The upper row of the Top Display defines the range and the type of probe for each channel.

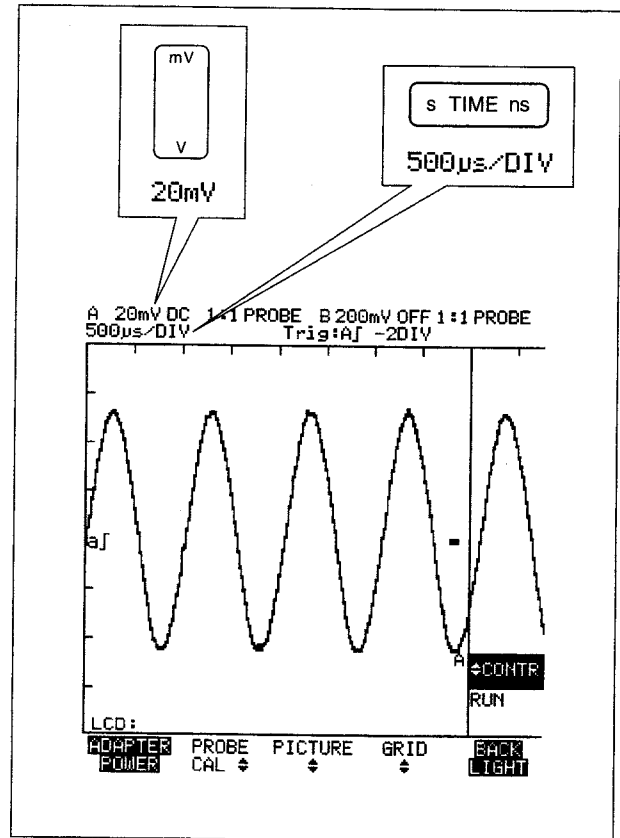



Figure 3-5. Time Base and Amplitude Adjustment

97/AUTO

Users Manual

Press  or  (for channel A or B) to step through the attenuator ranges, selecting one range for each channel. Refer to Figure 3-6. A summary of available ranges is presented below:

- 1:1 Test Leads: 1 mV; 2 mV; 5 mV; 10 mV; 20 mV; 50 mV; 100 mV; 200 mV; 500 mV; 1V; 2V; 5V; 10V; 20V; 50V; 100V
- 10:1 Probes: 10 mV; 20 mV; 50 mV; 100 mV; 200 mV; 500 mV; 1V; 2V; 5V; 10V; 20V; 50V; 100V; 200V; 500V; 1 kV

When a 10:1 probe is used with the 10 mV or 20 mV range, averaging is turned on automatically (AVG 4 appears on the display.) Averaging and MIN/MAX on A are mutually exclusive.



AUTOSET

The AUTOSET feature automatically selects the optimum settings for a connected input signal. Enter AUTOSET by pressing . For most signals, ScopeMeter automatically establishes amplitude and time base settings for an optimum display.

The main AUTOSET settings are as follows:



- Channel A and/or channel B is activated. All other waveform displays are deactivated.
- Between 2 and 8 periods of the signal with the lowest frequency (<5 MHz) are displayed.
- The attenuation is set so that the signal occupies about four vertical divisions most of the time.
- The trigger source with the lowest frequency is selected.

AUTOSET can be configured through the  Auto Set Pop-Up Menu. Refer to Section 4 for a complete description.

If no triggerable signal is found when you press , approximate settings are used. If the input signal subsequently changes, AUTOSET does not readjust by itself; you must press  again. Also, note that AUTOSET does not adjust display parameters for a stored or recalled waveform; an active signal input is required.



POSITIONING THE WAVEFORM ON THE DISPLAY

Considerable flexibility is offered in moving the trace(s) around the display.  and  reposition the trace up or down 4 divisions. This operation can be done separately for each channel. The  key simultaneously repositions both traces left or right from -4 to +16.5 divisions. Waveform positioning is demonstrated in Figure 3-6.

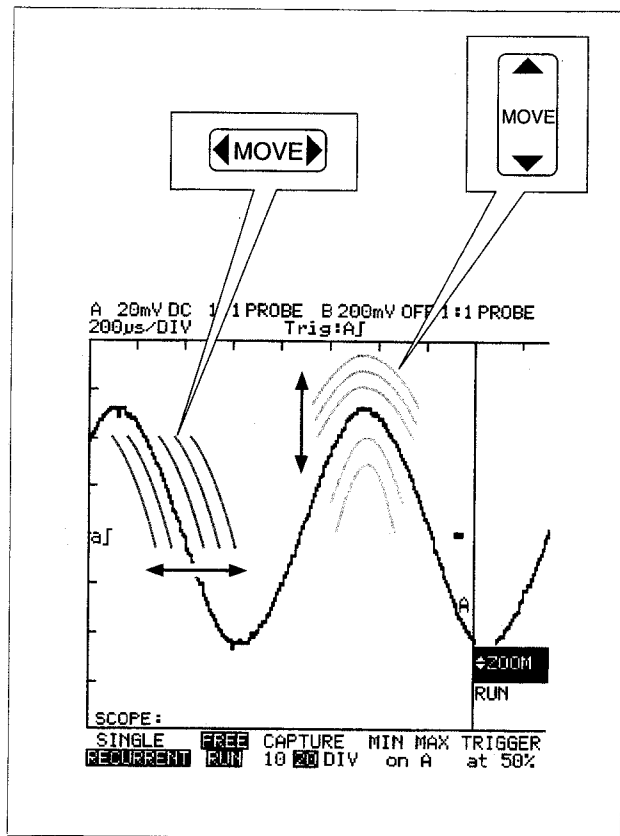
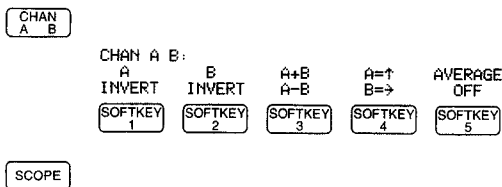

Figure 3-6. Positioning the Waveform

CHANNEL SELECTION

Press **CHAN** $\begin{matrix} \text{CHAN} \\ \text{A} \quad \text{B} \end{matrix}$ to access the Channel Selection Softkey Menu. You can now use **SFTKEY** $\begin{matrix} \text{SFTKEY} \\ 1 \end{matrix}$ **SFTKEY** $\begin{matrix} \text{SFTKEY} \\ 2 \end{matrix}$ to select the display configuration for channels A and B. Other selections (**SFTKEY** $\begin{matrix} \text{SFTKEY} \\ 3 \end{matrix}$ **SFTKEY** $\begin{matrix} \text{SFTKEY} \\ 4 \end{matrix}$ **SFTKEY** $\begin{matrix} \text{SFTKEY} \\ 5 \end{matrix}$) are discussed in Section 4.



Channel Softkey Menu

The INVERT selection reverses the displayed polarity of the icon and the displayed waveform. A reversed-polarity waveform is identified with a reverse video waveform identifier and trigger icon.

For example, a negative-going signal would be displayed as positive-going, providing a more meaningful viewing perspective in some cases. With same polarity signals on channels A and B, inverting only one channel allows for better signal comparison.

NOTE

*At least one signal display must be in effect at all times. Highlighting any selection accessed with **SFTKEY** $\begin{matrix} \text{SFTKEY} \\ 1 \end{matrix}$, **SFTKEY** $\begin{matrix} \text{SFTKEY} \\ 2 \end{matrix}$, **SFTKEY** $\begin{matrix} \text{SFTKEY} \\ 3 \end{matrix}$, or **SFTKEY** $\begin{matrix} \text{SFTKEY} \\ 4 \end{matrix}$ satisfies this requirement. A signal recalled from memory can also satisfy this requirement.*

Observe the following special rules for channel selections:

1. A maximum of four waveforms can be displayed at the same time. For example, channels A and B, A+B, and one waveform recalled from memory could all be displayed at the same time.
2. If MIN MAX on A is selected from the Scope Mode Softkey Menu, only **SFTKEY** $\begin{matrix} \text{SFTKEY} \\ 1 \end{matrix}$ can be used in the Channel Selection Softkey Menu.



AVERAGING

ScopeMeter can average multiple samples of a waveform, allowing for noise suppression without loss of bandwidth. Activate averaging in the Scope Mode with the following procedure:

1. Press \rightarrow **AVG** now appears in the right display.
2. Press to select the number of waveforms to average for each display update. The maximum number is 256.
3. Press (**AVERAGE OFF**) to turn off averaging, resetting the factor to 1.

NOTE

AVERAGE OFF changes to **AVERAGE MIN** in the 1 mV and 2 mV attenuator ranges. The minimum factor is then set to 4 when is pressed.

Additional information about averaging appears in Section 4. Waveform samples with and without averaging are shown in Figure 3-7.

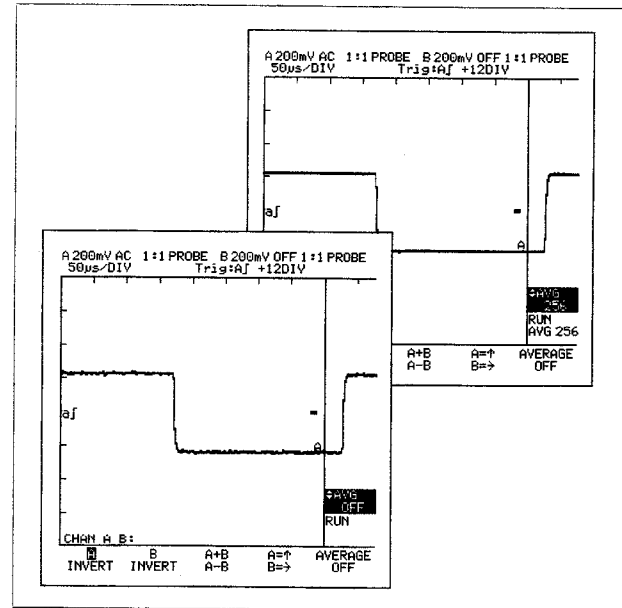

Figure 3-7. Averaging

DISPLAYING MULTIPLE WAVEFORMS

By displaying a combination of measurement channels and stored waveforms, a maximum of four traces can be displayed simultaneously. For example, channels A, B, A+B, and/or waveforms recalled from memory could be displayed. You can display any combination of four waveforms. At least one waveform trace must be turned on (A, B, A±B, or a memory) any time ScopeMeter is in Scope Mode. A multiple waveform display is shown in Figure 3-8.

NOTE

The A versus B (A↑ B→) display cannot be counted in the four-trace maximum.

If you attempt to display a fifth waveform, the following message is displayed:

Not executed: already max. traces on LCD

Channels A and B are continuously stored in the acquisition memories for use in Channel Math Operations (A+B, A-B).

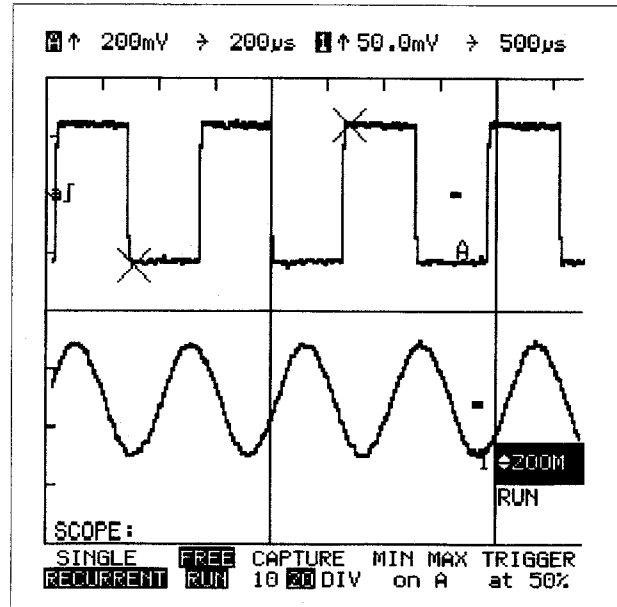

Figure 3-8. Multiple Waveforms





SCOPE RECORD MODE (MIN/MAX on A)



Scope Record stores and displays the events that occur between two samples on channel A. Channel B is automatically turned off. The events can be glitches or other asynchronous signals that are 40 ns or wider.

The glitches between the samples can still be stored and displayed using MIN MAX on A. Results are displayed as overruns (new maximums or minimums) of the previously displayed signal.

WAVEFORM QUICK STORAGE

Acquired waveforms on channel A, channel B, and A±B can be stored automatically by pressing  . The waveforms are stored in temporary memories 1, 2, and 3, respectively. The display continues to show the actual input signal and the cursor functions.

You can view the stored waveforms with the following procedure:



1. Press .
2. Press  (ON/OFF) to access the Waveform ON/OFF Pop-Up Menu. A list of eight memory locations now appears. A small square appears next to a memory if something is stored in that memory.



3. Press   to highlight:

- Temp. 1 (Channel A)
- Temp. 2 (Channel B)
- Temp. 3 (A±B)

4. Press  to display the waveforms in these memory locations. A large square appears next to each memory so selected. Remember that a maximum of four waveforms can appear on the display at one time. Refer to "Storing and Retrieving Waveforms" in Section 4 of this manual.

USING THE CURSOR

Cursors allow you to make precise digital measurements of waveform activity. Press  to access the Cursor Data Softkey Menu. Cursors can now be activated and deactivated by pressing . Activated cursors appear on the screen as two vertical and two horizontal dashed lines. Figure 3-9 shows a representative ScopeMeter display with cursors activated.

- The vertical cursor on the left is a series of long dashes and can be moved left or right by pressing .
- The vertical cursor on the right is a series of shorter dashes and can be moved left or right by pressing .
- Horizontally, another long-dash cursor appears above a short-dash cursor; these two cursors

track automatically with upper and lower peaks of the signal and cannot be controlled with a key.

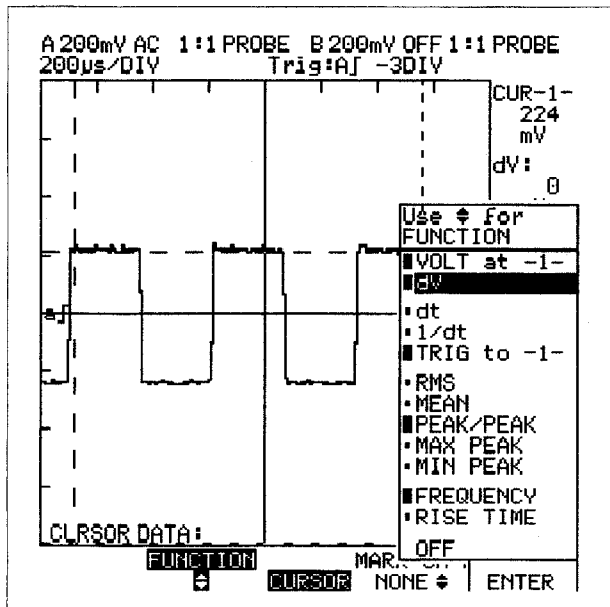

Figure 3-9. Using the Cursors

Cursor Source

Press **SOFTKEY₁** to select the waveform for cursor measurements. The cursor source selection is determined by active display traces. The traces can be obtained from the active display (A, B, \pm) or from memory (1 through 8).

Cursor Function

Press **SOFTKEY₂** to select the cursor FUNCTION. The Cursor Function Pop-Up Menu opens, allowing you to select the cursor measurement types to display. ScopeMeter uses waveform activity between vertical and horizontal cursors in making cursor function calculations.

The measurement results are displayed in the Right Display area. A maximum of five measuring functions can be turned on at the same time. Following is a list of the functions as defined in the Cursor Function Pop-Up Menu along with the corresponding identifiers used in the Right Display:

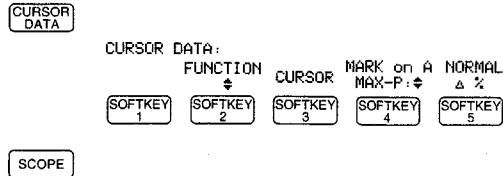

Cursor Data Softkey Menu

- **VOLT at -1- (CUR-1-)** Measure the voltage amplitude where cursor 1 crosses the waveform.
- **dV (dV: for delta Volts)** Measure the voltage difference between cursors.
- **dt (dt: for delta time)** Measure the time difference between cursors.
- **1/dt (1/dt: for relative frequency)** Show the reciprocal value of dt.
- **TRIG to -1- (Jto-1-)** Measure the time difference between the trigger occurrence and cursor 1.
- **RMS (RMS:)** Measure the RMS voltage between cursors.
- **MEAN (MEAN:)** Measure the MEAN (average of readings) value of signal between cursors.
- **PEAK/PEAK (P/P:)** Measure the PEAK to PEAK

value of signal between cursors.

- **MAX PEAK (MAX-P:)** Measure the maximum peak value of the signal between cursors.
- **MIN PEAK (MIN-P:)** Measure the minimum peak value of the signal between cursors.
- **FREQUENCY (FREQ:)** Measure the frequency of the signal between cursors. At least 1-1/2 cycles of this signal must occur between the cursors.

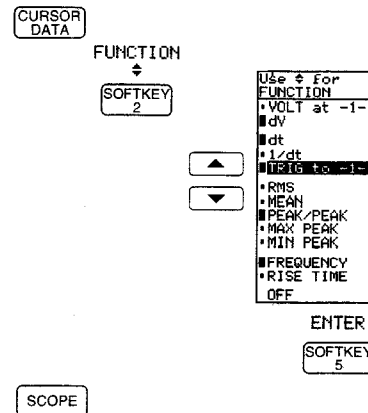

Cursor Function Pop-Up Menu

- **RISE TIME (RISE:)** Measure the rise time between 10% and 90% points of the signal. The 0% and 100% points are determined by the intersection of the signal and the cursors.

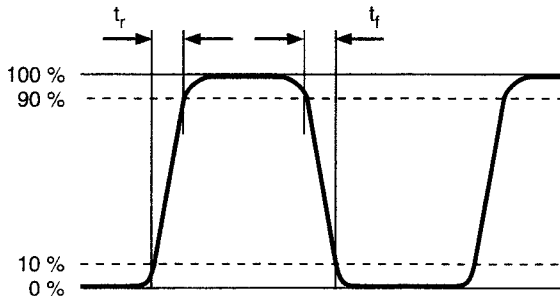

Rise Time

- **PHASE (PHASE:)** Measure the phase shift between two traces. A maximum of three phase shifts is possible.

Scrolling

A varying frequency waveform can be read easily with ScopeMeter. With the CURSOR DATA FUNCTION set to read FREQUENCY, you can scroll a waveform through the cursors by pressing **◀MOVE▶**. Read the frequency change in the Right Side Display.

Markers

Use the marker to identify the point on the waveform that a measurement has occurred or is expected to occur. The marker appears on the waveform as an "X". In Figure 3-10, the markers are defining sample points for measuring frequency.

From the Cursor Data Softkey Menu, press **SOFTKEY 4**. The Marker Pop-Up Menu now opens. Use **SOFTKEY 5** to highlight the marker use, then press **SOFTKEY 5**. The selected use (P/P:, MAX-P:, MIN-P:, FREQ:, RISE:, PHASE:, NONE) is then abbreviated under the MARK on X indication in the Cursor Data Softkey Menu.

NOTE

Markers may be easier to see in REVERSE or when you press **HOLD RUN**.

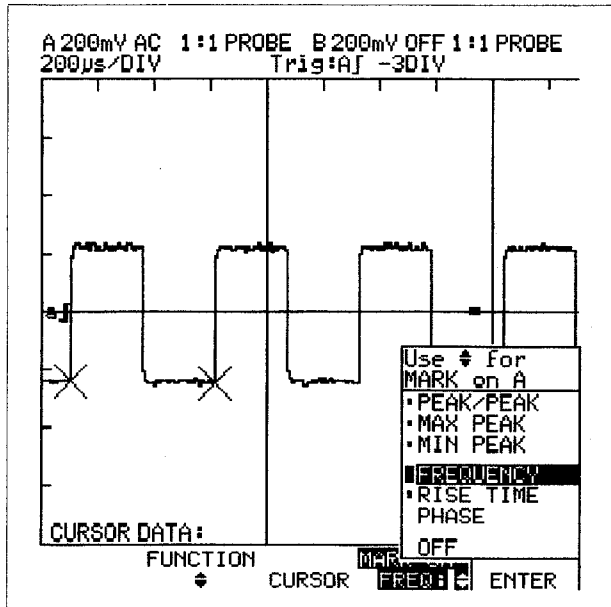
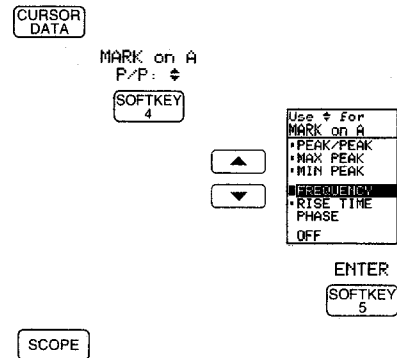

Figure 3-10. Markers (Frequency)

Cursor Positioning

Press \leftarrow [CURSOR] \rightarrow to position the left cursor on the display. Press \leftarrow [CURSOR] \rightarrow to position the right cursor.



Cursor Marker Pop-Up Menu

MORE INFORMATION

Sections 5 and 6 present Scope Mode applications that use many of the features discussed here in Section 3. Also, refer to Section 4 for a discussion of additional capabilities.

HELP

If you are having trouble displaying a waveform, make the following checks:

1. Try a shortcut first: press **AUTO SET**. ScopeMeter attempts to set its own the correct voltage scale, time base, and trigger level to display a meaningful representation of its input signal. Auto Set may not yield a good display in some instances. For example, signals with very low frequencies (lower than 50 or 60 Hz) may be a problem. In these cases, Meter Mode can help once again.
2. Is ScopeMeter the problem? Verify this by connecting to a known good signal. As shown earlier in this manual, connecting ScopeMeter's GENERATOR OUT to CHANNEL A provides a good test.
3. If ScopeMeter displays the known-good signal, check to see if the problem waveform actually exists. Check this by selecting the Meter Mode (press **METER**). Check for voltage and frequency.
4. If ScopeMeter displays a voltage reading but not a frequency indication, there is a signal but a frequency may not be detected.
5. If the voltage is close to zero, you may have a bad input connection.
6. If ScopeMeter displays both voltage and frequency, a signal probably exists. The signal is not being displayed in Scope Mode because

ScopeMeter settings are incorrect. Now go back to Scope Mode. Press **SCOPE** and check the following areas:

- Verify that RECURRENT and FREE RUN are on, allowing ScopeMeter to display a waveform even if the trigger requirements are not met.
 - Check for a trigger source (A, B, G, or X and trigger icon in the lower row of the top display.)
 - Check that your input channel is active. OFF appears in the upper row of the top display if your input channel is turned off. If necessary, press **CHAN A B** and turn the channel on.
 - Check input coupling. If necessary, press **AC DC GROUND** for your input channel to select DC as seen in the upper row of the top display. This action allows you to view both ac and dc signals.
 - Verify that NOTRIG is flashing in the Right Display. If HOLD is flashing, press **HOLD RUN**.
7. If you still do not have a signal, you will need to check settings in the following four areas:
 - Voltage Scale
 - Time Base
 - Trigger Level
 - Coupling



8. Press **METER** **SOFTKEY**₁ (Meter Mode, V DC). Use the readings to make the following best guesses for Scope Mode settings:
- Divide the Meter Mode displayed voltage level by 10 to approximate a Scope Mode voltage per division. This technique gives you a starting place for further voltage scale adjustment.
 - Set the Scope Mode trigger level at approximately 50% of the displayed voltage in Meter Mode. Press **SCOPE** **SOFTKEY**₅ for TRIGGER at 50%.
 - Use the frequency measured in Meter Mode to approximate a time base setting. Use Table 3-1 as a guide in making this calculation.

Table 3-1. Choosing a Time Base

Frequency	1 cycle	2 cycles	3 cycles	4 cycles	5 cycles
10 Hz	10ms	20ms	50ms	50ms	50ms
20 Hz	5ms	10ms	20ms	20ms	50ms
30 Hz	5ms	10ms	10ms	20ms	20ms
40 Hz	5ms	5ms	10ms	10ms	20ms
50 Hz	2ms	5ms	10ms	10ms	10ms
60 Hz	2ms	5ms	5ms	10ms	10ms
70 Hz	2ms	5ms	5ms	10ms	10ms
80 Hz	2ms	5ms	5ms	5ms	10ms
90 Hz	2ms	5ms	5ms	5ms	10ms
100 Hz	1ms	2ms	5ms	5ms	5ms
200 Hz	500 μ s	1ms	2ms	2ms	5ms
300 Hz	500 μ s	1ms	1ms	2ms	2ms
400 Hz	500 μ s	500 μ s	1ms	1ms	2ms
500 Hz	200 μ s	500 μ s	1ms	1ms	1ms
600 Hz	200 μ s	500 μ s	500 μ s	1ms	1ms
700 Hz	200 μ s	500 μ s	500 μ s	1ms	1ms
800 Hz	200 μ s	500 μ s	500 μ s	500 μ s	1ms
900 Hz	200 μ s	500 μ s	500 μ s	500 μ s	1ms
1000 Hz	100 μ s	200 μ s	500 μ s	500 μ s	500us
2000 Hz	50 μ s	100 μ s	200 μ s	200 μ s	500us
3000 Hz	50 μ s	100 μ s	100 μ s	200 μ s	200us
4000 Hz	50 μ s	50 μ s	100 μ s	100 μ s	200us
5000 Hz	20 μ s	50 μ s	100 μ s	100 μ s	100us

Section 4

Additional Capabilities

Contents

INTRODUCTION	4-2	%Δ	4-10
GENERAL USE (METER AND SCOPE MODES)	4-2	SCALING	4-12
Printing	4-2	VOLT MATH	4-13
PRINT FORMAT	4-2	Meter Record Scaling	4-13
PRINTER SETUP	4-3	Meter Record Zero	4-15
DIRECT PRINTING	4-3	SCOPE MODE ONLY	4-16
PRINTING FROM A PC	4-4	Channel Math	4-16
START PRINT	4-4	Storing and Retrieving Waveforms	4-18
Startup Configuration	4-4	Waveform Math	4-20
Configuring Autoset	4-5	ADD	4-22
Master Reset Configuration	4-7	SUBTRACT	4-22
Performing a Master Reset	4-7	MULTIPLY	4-22
Clearing Memory	4-8	INVERT	4-23
Measuring Components	4-8	INTEGRATE	4-23
Using the Signal Generator	4-9	FILTER	4-23
Minimizing Signal Noise	4-9	Useful Techniques	4-24
METER MODE ONLY	4-10	QUICK METER CHECKS	4-24
Display Modes	4-10	DISPLAY HOLD	4-24
DUTY CYCLE	4-10		

INTRODUCTION

This section describes some advanced, less frequently used ScopeMeter features. As with other areas of the manual, these features are presented in groups for general usage (Scope and Meter Modes), Meter Mode only usage, and Scope Mode only usage.

GENERAL USE (METER AND SCOPE MODES)**Printing**

Refer to the Users Manual provided with the RS-232-C Interface Adapter for complete printer connection and operation instructions. This adapter is available by ordering the K97A Accessory Kit from your tool supplier.

The following instructions relate to actions you must take at the ScopeMeter end of this operation.

PRINT FORMAT

Press **SPECIAL FUNCT** to access the Special Functions Softkey Menu. Then press **SOFTKEY 3** to enter the Print Format Pop-Up Menu. You can now choose the type of information to print.

This menu is organized into the following three groups:

- **SCREEN** (default setting) Print the currently displayed ScopeMeter screen.
- **LOG readings** Set the reading repeat time for cursor data.
- **WAVEFORM** Print out the selected waveform. The waveform is printed in a numerical format that represents sample data points.

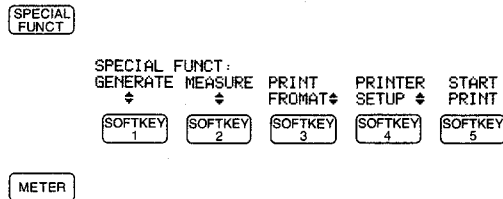
**Special Function Softkey Menu**

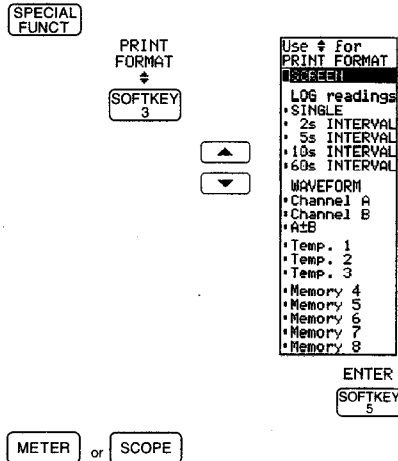

Print Format Pop-Up Menu

PRINTER SETUP

ScopeMeter can print directly to an FX/LQ (Epson) type or HP ThinkJet laser type printer at 1200 or 9600 baud. From the Special Function Softkey Menu, press **SOFTKEY 4** to make these selections.

DIRECT PRINTING

You can print screens and log data directly if your printer can provide power to the ScopeMeter RS-232-C interface (RTS and DTR lines active). Some printers do not provide this support. If your printer does not provide this support, or if there is any doubt that it can, it is generally better to use a PC as a print control device.

PRINTING FROM A PC

The RS-232-C interface allows you to transfer a screen or log data to the PC, then print from the PC.

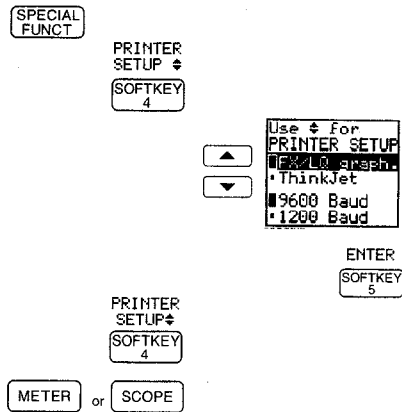

Printer Setup Pop-Up Menu

START PRINT

Whether you are printing directly to a printer or through a PC, press **SOFTKEY 5** from the Special Function Softkey Menu to start printing via the ScopeMeter serial RS-232-C port. The settings you made in the Print Format and the Printer Setup Pop-Up Menus will be used.

Startup Configuration

When **ON/OFF** is pressed ON, ScopeMeter begins operation in the last-known configuration and the LCD Softkey Menu appears. Factory default settings are used at the first power up. Subsequent power ups assume configuration changes made with keystrokes or through recall of a setup memory during the previous session.

Some of the configuration settings can be preset to become active at every power up. Press **SETUP**, then access these selections from the Setup Softkey Menu by pressing **SOFTKEY 4**. The Initial Setup Pop-Up Menu appears.



The first part of these selections defines some basic actions taken at Auto Set. Here, you can specify whether Auto Set will attempt to optimize the attenuator (only AMPL.), the time base (only TIME), or both (TIME & AMPL.). Note that you must also choose \approx INIT. SET. in the Auto Set Pop-Up Menu to use your attenuator/time base optimization selection. The factory default optimization is only AMPL.

The next part of the Initial Setup Pop-Up Menu selects some Scope Mode setups. You can specify whether to identify the waveform (trace) source (TRACE I.D.), whether to identify the trigger source and slope (TRIGGER I.D.), and whether to CLEAR at RUN. Factory defaults place all three of these items on.

A final part of the Initial Setup Pop-Up Menu specifies the period for Scope Record updates. The factory default is INFINITE. Other selections are 2, 5, 10, or 60 seconds (or acquisitions.)

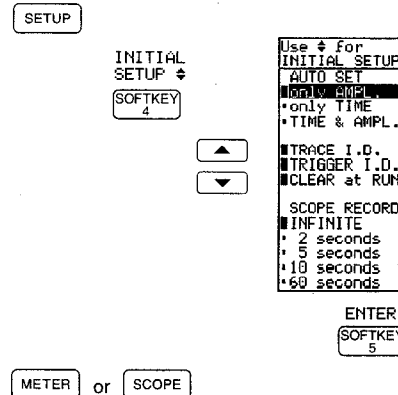

Initial Setup Pop-Up Menu

Configuring Autoset

When **AUTO SET** is pressed, ScopeMeter assumes the autoset configuration. To change this configuration, press **SETUP** to access the Setup Softkey Menu, then press **SOFTKEY 5**. The Autoset Pop-Up Menu appears.

The items shown in this menu are divided into the following four groups:

1. AUTO SET source

- a. COMPLETE (Default is ON)
- b. ~~as~~ INIT. SET (Default is OFF)

NOTE

Choose COMPLETE for best predictability. If you choose ~~as~~ INIT. SET, the time base assumed may not be predictable, depending on your optimization selection in the Initial Setup Pop-Up Menu.

2. Triggering: selections

- a. 50% LEVEL (Default is ON)
- b. DELAY OFF (Default is ON)
- c. POS. SLOPE (Default is ON)
- d. INCLUDE EXT. (Default is OFF)

3. CHAN A B: setup

- a. SEPARATE (Default is ON)
- b. NO AVERAGE (Default is ON)
- c. COUPLING AC (Default is ON)

4. Turns off: Items that are turned off when  is pressed. An item marked with a large black square here is turned off; items marked with a small square are turned on.

- a. X- MOVE (Default is OFF)
- b. Y- MOVE (Default is OFF)
- c. A=↑, B=→ (Default is OFF)
- d. CURSOR (Default is ON)
- e. DOT JOIN (Default is ON)
- f. MATH (Default is OFF)
- g. GENERATOR (Default is ON)

Items not listed here are not impacted by Auto Set.

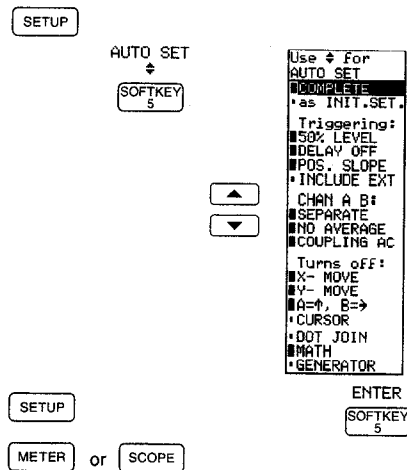

Auto Set Pop-Up Menu

Master Reset Configuration

Factory default settings are assumed when a master reset is performed. A master reset includes the following settings:

- Meter Mode
- Vrms AC + V DC
- LCD Screen, Backlight Off

- Probe Cal 10:1, Channels A and B
- Dot Join
- Dotsize 1
- Setup Memory cleared
- Waveform Memory cleared
- Generator Off
- Print Format Screen
- Printer Setup FX/LQ graph, 1200 Baud
- Autoranging

Performing a Master Reset

A master reset clears all setups and memories and sets ScopeMeter to the Meter Mode.

NOTE

A master reset also clears both WAVEFORM and SETUP memories.

1. Press **ON/OFF** to turn ScopeMeter off.
2. While holding **LCD** pressed, momentarily press **ON/OFF**. After you hear the double beep, release **LCD**.
3. Since a master reset selects the 10:1 probe, you must specifically select 1:1 to proceed with the examples shown in this manual. Do this by pressing **ON/OFF** OFF, then hold **SOFTKEY 1** while momentarily pressing and releasing **ON/OFF**. After you hear a beep, release **SOFTKEY 1**. ScopeMeter is now set for 1:1 on both channels.

Clearing Memory

Access the Memory Clear Softkey Menu at any time by pressing **SETUP** and **WAVEFORM** simultaneously.

You can now press **SOFTKEY 1**, **SOFTKEY 2** or **SOFTKEY 4** to clear ALL SETUP (setup memories 1 through 10), ALL WAVEFORM (temporary memories 1 through 3 and regular memories 4 through 8), or SETUP WAVEFORM (clear everything).

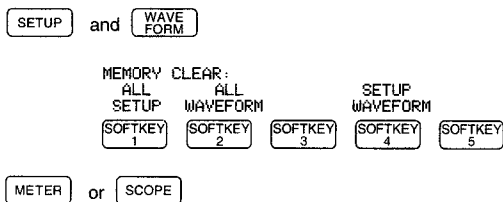

Memory Clear Softkey Menu

Measuring Components

From the Special Functions Softkey Menu, press **SOFTKEY 2** to use ScopeMeter as a special predefined measuring tool for components.

Depending on the menu selection, ScopeMeter outputs a slow voltage or current ramp. Connect the component to be tested to GENERATOR OUT and COM. Measure the component on CHANNEL A. The characteristics of the component tested are shown on the display.

Auto Set cannot be used with the Component Measurement Mode.

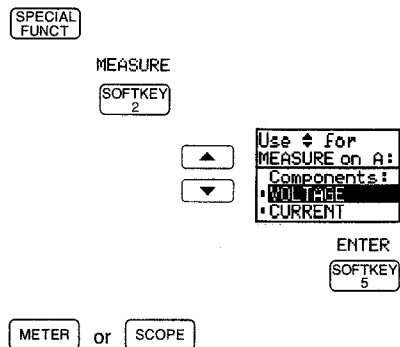

Component Measurement Pop-Up Menu



Using the Signal Generator

Press **SPECIAL FUNCT** to select the Special Functions Softkey Menu. Then press **SOFTKEY 1** to select the Generator Pop-Up Menu. You can now select a signal output at GENERATOR OUT and COM. The output choices are:

CAUTION

Do not use the signal generator to substitute for an automotive sensor signal. The generator output is not a sufficient source to drive transducers or other output devices.

- Square: 1.95kHz 976Hz 488Hz) (all at 5V p-p)
- SINE WAVE (1V p-p, 976 Hz)
- Slow ramp:
 - Voltage (-2V to 2V, 1 mA maximum)
 - Current (0 to 3 mA, 2V maximum)

The generator is automatically disabled if the mV DC, Ω , or * function is active.

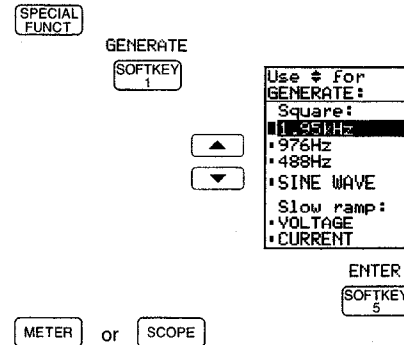

Generator Pop-Up Menu

The generator output also can be selected as trigger source.

Minimizing Signal Noise

In general, using your ScopeMeter on battery power only will minimize noise pickup. Further, using the 10:1 accessory probe will help in noise rejection. This probe is available by ordering the K97A Accessory Kit from your tool supplier.

If you are using the line voltage adapter (PM8907 or equivalent), connect a test lead from the ScopeMeter banana jack COM (common) to the measurement common (ground) of the system under test. This technique reduces or eliminates any power line related noise.

METER MODE ONLY

Display Modes

Refer to Section 2 for a general discussion of choices available in the Display Modes Pop-Up Menu. (Access this menu by pressing  when ScopeMeter is in Meter Mode.) The $\% \Delta$, SCALING, and VOLT MATH selections from this menu are dealt with in greater detail in the following paragraphs.

DUTY CYCLE

Select DUTY CYCLE to display the relative on-to-off time of a varying input signal. The main display then shows a percentage figure. You must select DUTY $\%+$ or DUTY $\%-$ to display the duty cycle of the input above or below the fixed reference level, respectively. See Figure 4-1 for an example of duty cycle calculation.

Duty cycle can easily be converted to degrees of dwell in automotive measurements by using the table found in Appendix 8F of this manual.

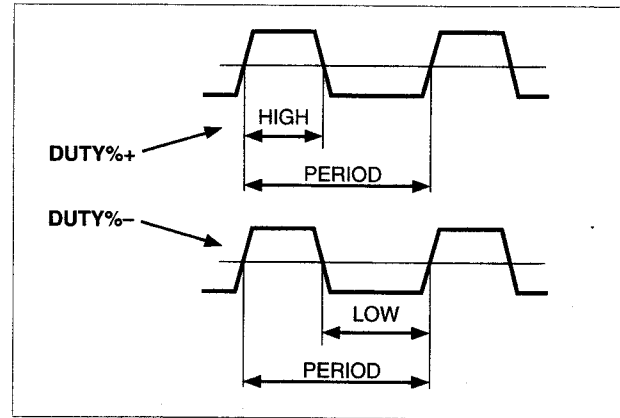



Figure 4-1. Duty Cycle Calculation

$\% \Delta$

Percentage change (delta) uses the present reading as a relative reference. The display then shows an updating percentage, representing the amount of difference between each new reading and the relative reference.

$\% \Delta$ appears in the  definition and next to the function description.

A new reading is calculated with the following formula:

$$\% \Delta \text{ reading} = \left(\frac{\text{new reading} - \text{ref. reading}}{\text{ref. reading}} \right) * 100\%$$

%Delta Formula

Figure 4-2 shows percentage change (tolerance) when measuring a resistor.

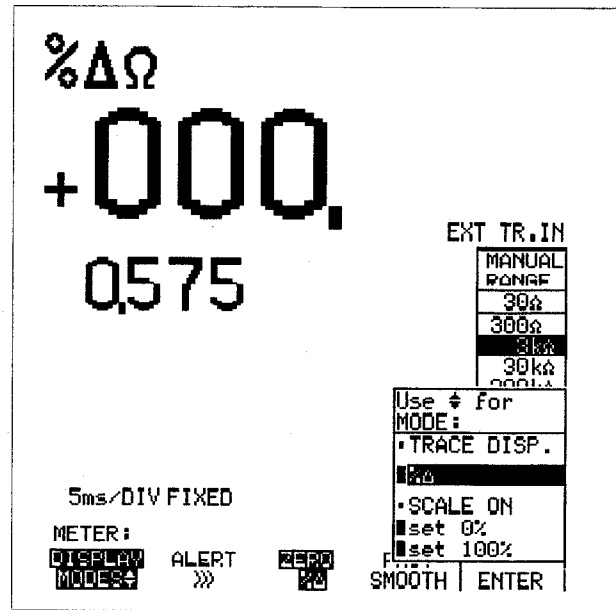

Figure 4-2. %Delta Display



SCALING



Scaling displays the present measurement result with respect to a defined range with a 0% and 100% value. Entering the 0% and 100% values automatically selects **SCALE ON**. The scaled display value is calculated using the following formula:

$$\% \text{ reading} = \left(\frac{\text{new reading} - 0\% \text{ value}}{100\% \text{ value} - 0\% \text{ value}} \right) * 100$$



Scaling Formula

Scaling starts automatically when both 0% and 100% values have been entered. Use the following procedure:

1. Press one of the five Meter Mode softkeys.
2. Measure the value that will represent 0%.
3. Press  (**DISPLAY MODES**).
4. Press  to highlight **set 0%**.
5. Press  (**ENTER**) to store the displayed value as 0%.

6. Now measure the value that will represent 100%.
7. Press  (**DISPLAY MODES**).
8. Press  to highlight **set 100%**.
9. Press  (**ENTER**) to store the displayed value as 100%.

You can stop scaling with either of the following actions:

- Select another function.
- Press  (**DISPLAY MODES**), highlight **SCALE ON** in the Scaling section of the menu, and press  (**ENTER**).

As long as 0% and 100% remain defined, you can toggle Scaling on and off as needed. This procedure is useful when you are determining the percent change in a throttle valve opening, as measured by the throttle position sensor.

A typical scaling display is shown in Figure 4-3.

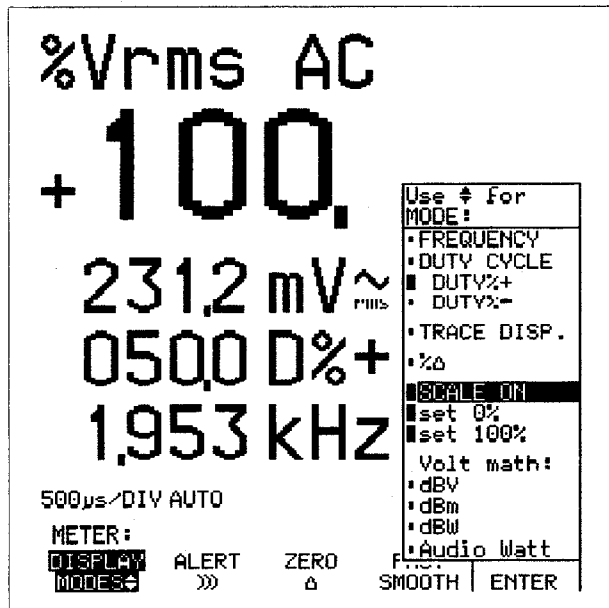



Figure 4-3. Scaling Display

VOLT MATH

Use one of the Volt math: selections to display the measurement in dBV (decibel Volts), dBm (decibel milliwatt), dBW (decibel Watt), or Audio Watt. For dBm, dBW, and Audio Watt, a range of reference impedances (Rload can be selected next by pressing  or .

For dBm, the following reference impedances can be selected: 50, 60, 75, 93, 110, 125, 135, 150, 250, 300, 500, 600, 800, 900, 1000 and 1200Ω.

For dBW and Audio Watt, the following reference impedances can be selected: 1, 2, 4, 8, 16 and 50Ω.

Meter Record Scaling

The Meter Mode Softkey Menu offers you access to a scaling function when ScopeMeter is in Meter Record Mode. Press  DISPLAY MODES; the Meter Record Display Modes Pop-Up Menu appears.

METER

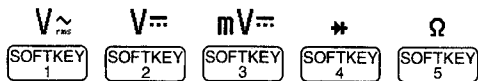

RECORD

METER
DISPLAY
MODES

SOFTKEY
1



```

Use ↕ For
MODE:
• FREQUENCY
• DUTY CYCLE
■ DUTY%+
• DUTY%-
• %Δ
■ SCALE ON
• NOW as 0%
• MAX as 0%
• AVG as 0%
■ MIN as 0%
• NOW as 100%
■ MAX as 100%
• AVG as 100%
• MIN as 100%
Volt math:
• dBV
• dBm
• dBW
• Audio Watt
    
```

ENTER
SOFTKEY
5

RECORD

Scaling allows you to view the readings as relative percentage values. For example, you can determine how the existing reading (NOW) relates as a percentage of a range defined by two of the following settings: MIN, MAX, and AVG. You would accomplish this from the Meter Record Display Modes Pop-Up Menu as follows:

1. Press to highlight MIN at 0%. Press to activate this selection.
2. Press again, then highlight MAX at 100%. Press .
3. Since these entries set up a valid range, ScopeMeter begins scaling with a display similar to Figure 4-4.

Certain combinations of 0% and 100% points are invalid, resulting in the following message bar:

Invalid Reference: OL or divide by 0 err

NOTE

Scaling and zero selections are mutually exclusive; selecting one deactivates the other.

Meter Record Display Modes Pop-Up Menu

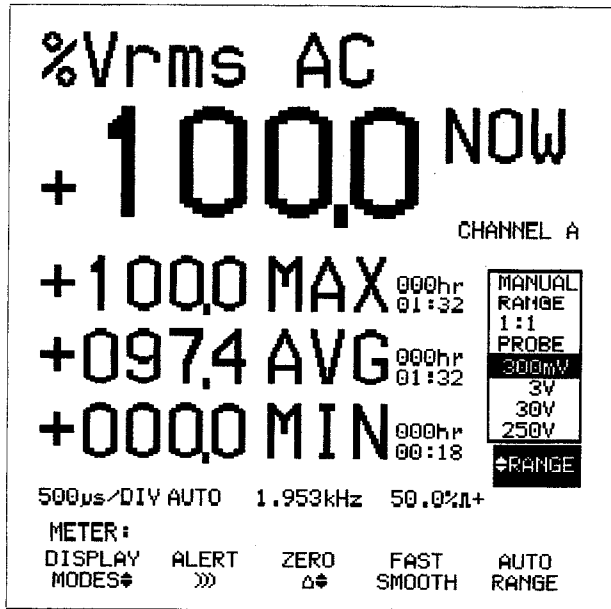
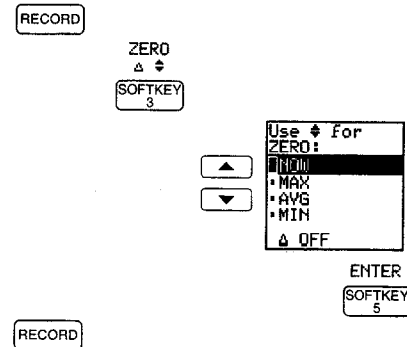

Figure 4-4. Meter Record Scaling

Meter Record Zero

Meter Record Zero allows you to view the relative readings in units appropriate for the function and range selected. When in Meter Record Mode, press **SOFTKEY 3** ZERO; the Meter Record Zero Pop-Up Menu appears. You can now select NOW, MAX, AVG or MIN as a zero reference value.



Meter Record Zero Pop-Up Menu

Press **SOFTKEY 3** to access the menu. Then press **SOFTKEY 5** to highlight your choice, followed by **SOFTKEY 5** to activate the selection. See Figure 4-5 for an example of the resulting display.

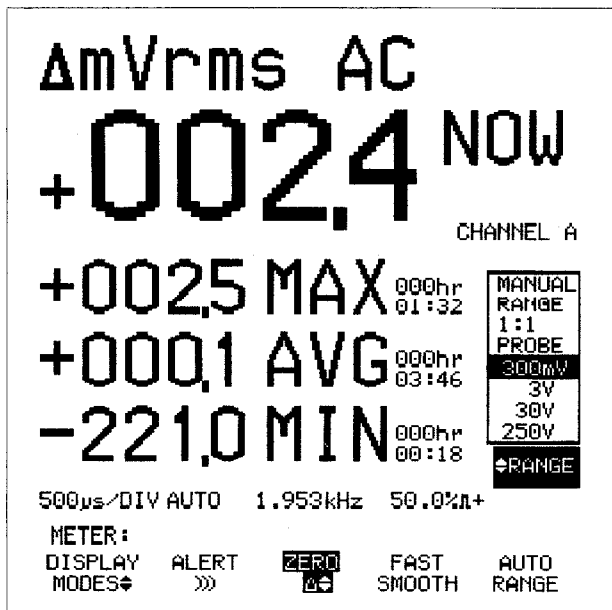



Figure 4-5. Meter Record Zero

SCOPE MODE ONLY



Channel Math

Press  to access the Channel Softkey Menu.

NOTE

If MIN MAX on A has been selected from the Scope Softkey Menu, the Channel Softkey Menu is restricted to one choice (A INVERT).

Selections from the Channel Softkey Menu are as follows:

-  Select A or A INVERT for a normal or inverted display of the signal on channel A, respectively. Select neither to turn channel A off.
-  Select B or B INVERT for a normal or inverted display of the signal on channel B, respectively. Select neither to turn channel B off.
-  Select A+B to show channels A and B added together. Select A-B to show channel B subtracted from channel A.
-  A=↑ B=⇒ provides a plot with channel A on the vertical axis and channel B on the horizontal axis.



NOTE

At least one of the items available with must be selected at all times. By this rule, you can turn channels A and B off if either or is active or if a stored waveform has been recalled to the display.

- ScopeMeter can average multiple waveforms, allowing for noise suppression without loss of bandwidth. When ∇ AVG is shown in the right display, press to select the number of waveforms to average for each display update. The maximum number is 256. Press to reset the number to 0.

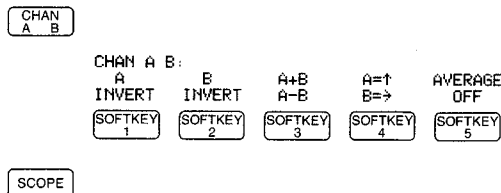

Channel Softkey Menu

NOTE

AVERAGE OFF changes to AVERAGE MIN in the 1 mV and 2 mV attenuator ranges. The minimum factor is then set to 4 when is pressed.

You can use and from the Channel Softkey Menu to set the average factor. The factor is displayed under ∇ AVG in the Right Menu area. Press (AVERAGE OFF) to turn off averaging, resetting the factor to 1.

In the following circumstances, the minimum average factor is automatically set to 4:

- 1:1 Probe Selection: 1 mV and 2 mV attenuator ranges.
- 10:1 Probe Selection: 10 mV and 20 mV attenuator ranges.

You can still select higher factors with , but pressing (AVERAGE MIN) returns the factor to 4. To turn off this setting, press to increment the attenuator to 5 mV (for 1:1) or 50 mV (for 10:1).

Storing and Retrieving Waveforms

You can save waveforms to memory, copy waveforms between memories, and recall waveforms from memory. Three acquisition memories, three temporary registers, and five nonvolatile memories are available.

The temporary registers are used to save the contents of the acquisition memories A, B, and A+/-B (Mathematics), if active, in one action.

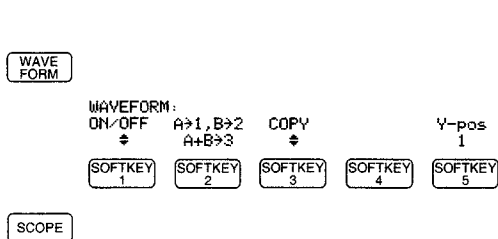

Waveform Softkey Menu

In the Waveform ON/OFF Pop-Up Menu, the saved waveforms and the corresponding setup can be recalled. A small dot in front of the item indicates that the memory location is filled with a waveform. A large dot in front of an item indicates that the waveform is displayed. A displayed waveform has a figure indication that corresponds with the waveform memory number.

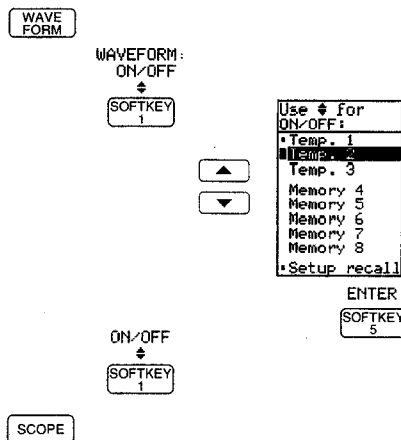

Waveform ON/OFF Pop-Up Menu



A maximum of four waveforms can be displayed at one time.

When Ψ -pos is displayed in the Right Display, press \downarrow \uparrow to reposition any of the displayed waveforms from memory. Select the waveforms separately by pressing SOFTKEY_5 .

Press SOFTKEY_2 to perform a simultaneous copy of acquisition memories A, B and A±B to waveform temporary registers 1, 2, and 3, respectively.

Press SOFTKEY_3 to copy a waveform to another memory. Waveforms from acquisition memories A, B or A±B, temporary memories 1, 2, and 3, or regular memories 4 through 8 can be selected for copying to memories 1 through 8.

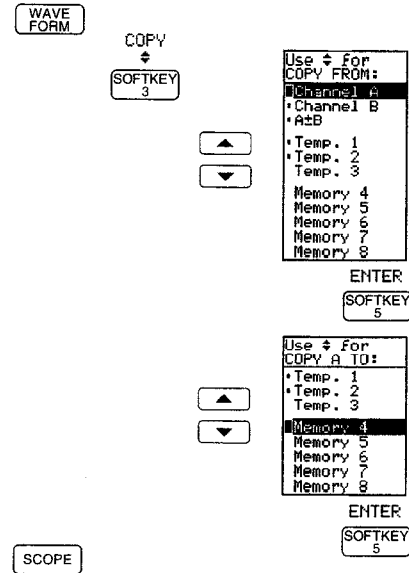

Waveform Copy From/To Pop-Up Menus

Waveform Math

Press **MATH** to access the Math Softkey Menu. You can now use the various memories to perform several math functions. Press **SOFTKEY 1** to introduce yourself to the functions available.

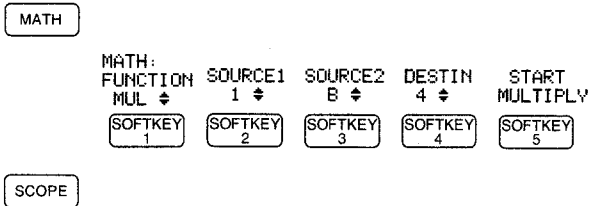

Math Softkey Menu

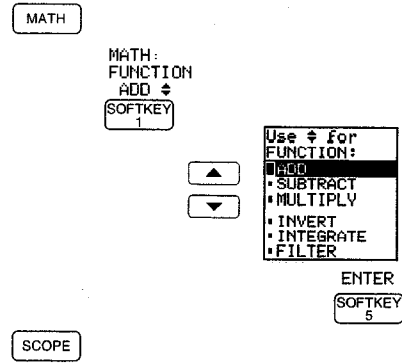

Math Function Pop-Up Menu



- ADD, SUBTRACT, and MULTIPLY require two operands (SOURCE1 and SOURCE2). The operands can be selected from acquisition memories, temporary waveform memories, or waveform memories.
- INVERT, INTEGRATE, and FILTER functions require one operand (SOURCE1) from acquisition memories, temporary waveform memories, or waveform memories.
- All functions require a DESTIN memory selection.

Start or stop the selected function by pressing **SOFTKEY 5**. You can view the math result by accessing the waveform memory that you used for the destination. Press **WAVE FORM**, then **SOFTKEY 1**. Highlight the desired waveform memory by pressing **▼** **▲**, then press **SOFTKEY 5**.

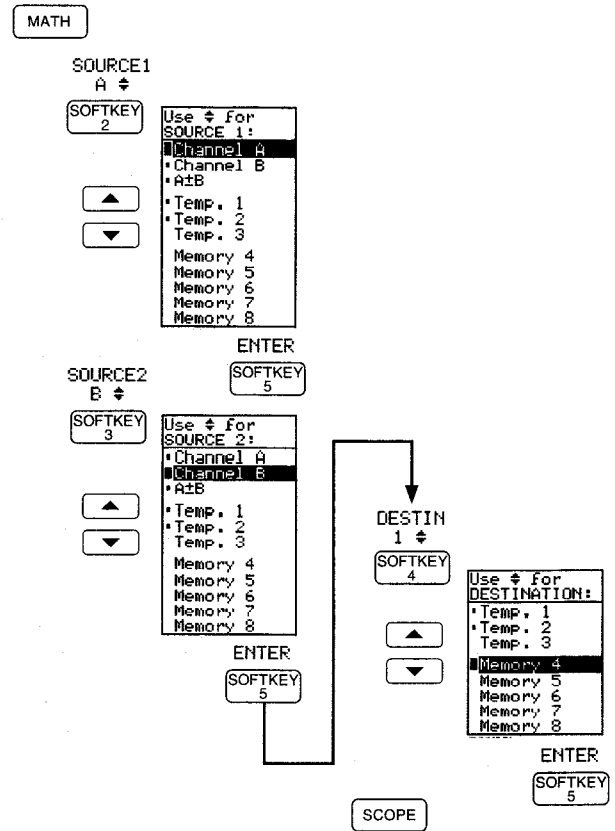

Math Source1/Source2/Destin Pop-Up Menus

While the Math Softkey Menu is displayed, \uparrow SCALE appears in the right display. The Scale factor allows you to adjust the display to accommodate the math result. You can now press \square \square to select none, $\sqrt{5}$, $\sqrt{25}$, or $\sqrt{125}$.

ADD

This math function adds two traces (each sourced from an active channel or a memory location) and stores the result in a chosen memory location. For example, waveforms from channel A (SOURCE1) and memory 1 (SOURCE2) can be added, resulting in a waveform stored in memory 4 (DESTIN).

SUBTRACT

This math function subtracts the SOURCE2 trace from the SOURCE1 trace and stores the result in the chosen memory location. As with ADD, active channels or memory locations can be used in any combination for the sources.

MULTIPLY

This math function multiplies two traces (each sourced from an active channel or a memory location) and stores the result in a chosen memory location. For example, power can be calculated with MULTIPLY if SOURCE1 represents the voltage drop

across a device and SOURCE2 represents current through that device. In Figure 4-6, waveforms from memory 1 (upper) and channel A (middle) are multiplied, resulting in the waveform stored in memory 4 (lower).

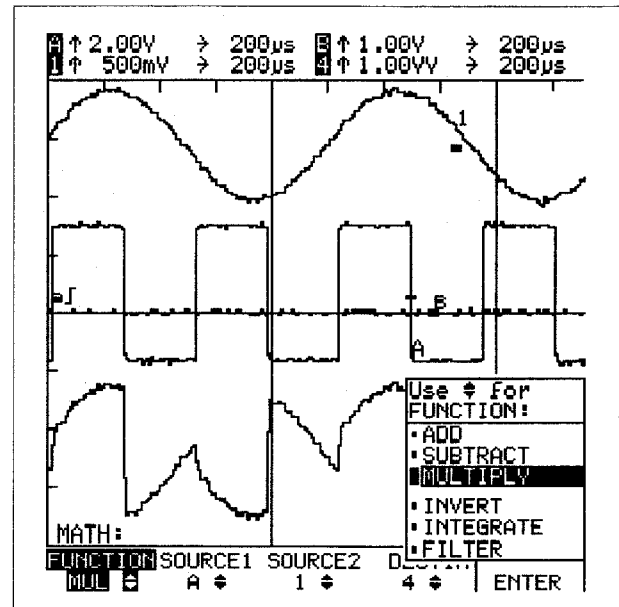

Figure 4-6. MATH Multiply



INVERT

INVERT allows you to reverse the polarity on an active channel or memory signal and store the new waveform in another memory location.

INTEGRATE

This function performs a numerical integration on the selected waveform.

FILTER

Any waveform (active channel or memory) can be filtered, with the resulting waveform stored in a new memory location. Noise suppression or simply waveform smoothing is thereby possible. Filtering is especially useful with single acquisition waveforms, where averaging of multiple waveform samples is not otherwise available. In Figure 4-7, the upper waveform represents the channel A signal as measured and the lower waveform represents the filtered version recalled from memory 4.

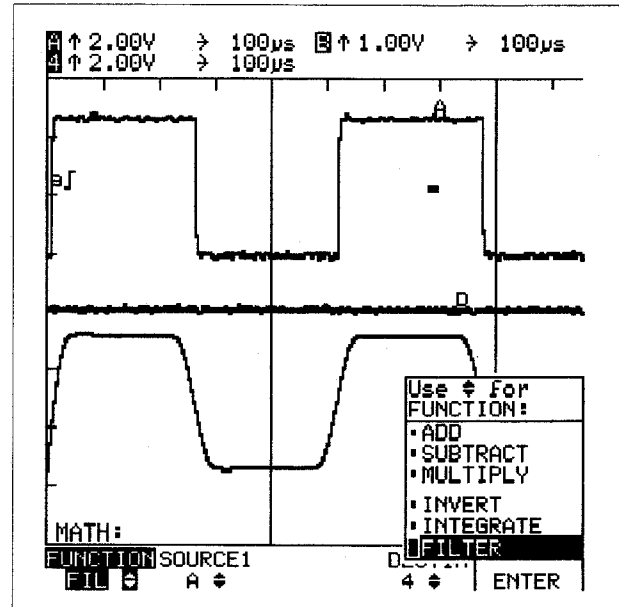

Figure 4-7. MATH Filtering

NOTE

In FILTER function, the -3 dB frequency is $0.8/\text{time-per-division}$.

Useful Techniques

QUICK METER CHECKS

You can set up DISPLAY MODES in Meter Mode to provide a custom display of scope measurements on Channel A. Then just press **METER** when you want a quick reading of these measurements. Press **SCOPE** again to return to Scope Mode.

DISPLAY HOLD

You will find many uses for the **HOLD RUN** key. For example, if you want to activate different cursors to measure a Scope Mode waveform, you can press **HOLD RUN**, change the cursors, and view the new cursor information while still in Display Hold.

Section 5 Applications

Contents

ALTERNATOR RIPPLE VOLTAGE	5-1	VARIABLE RELUCTANCE SENSORS (MAGNETIC).....	5-25
CLAMPING/SUPPRESSION DIODES	5-4	HALL EFFECT SENSORS.....	5-31
VARIABLE POSITION (POTENTIOMETER) SENSORS	5-9	ELECTRICAL INTERFERENCE (RFI OR EMI ON GROUND OR FEED)	5-35
KNOCK SENSOR (PIEZO CRYSTAL).....	5-15	OXYGEN SENSOR <==> FUEL INJECTOR OR MC SOLENOID	5-38
FUEL INJECTOR PULSE WIDTH.....	5-18		
OXYGEN SENSORS.....	5-21		

CAUTION

**Views of the ScopeMeter connections in this section are conceptualized only.
Refer to manufacturer service information for connection details.**

ALTERNATOR RIPPLE VOLTAGE

A set of diodes rectifies the ac voltage produced in the alternator to the dc voltage used by the car's systems. These diodes are included as part of the alternator, allowing for voltage measurement at the alternator. You will be looking for both ac and dc levels. The ac level is called ripple voltage and is a clear indication of diode condition. Too high a level of ac voltage can discharge the battery.

The Low Pass Filter Probe used here is available with the K97A Accessory Kit. Contact your tool distributor for more information.

- ① Connect ScopeMeter to the alternator as shown and use the Low Pass Filter Probe.
(All connections and setups apply to Channel A.)

②

③ SINGLE RECURRENT CAPTURE 10 20 DIV

④ PROBE CAL \updownarrow

Use \leftrightarrow For CAL & ADJUST:
 Channel A
 * 1:1
 * 10:1
 * 100:1
 * 1000:1
 * AC ADJUST
 * DC CAL
 Channel B
 * 1:1
 * 10:1
 * 100:1
 * 1000:1
 * AC ADJUST
 * DC CAL

- CHANNEL A
- ⑤ AC
- ⑥ 50mV/DIV To 20mS/DIV
 200 mV/DIV
- ⑦ Start engine.
- ⑧ TRIGGER at 50%

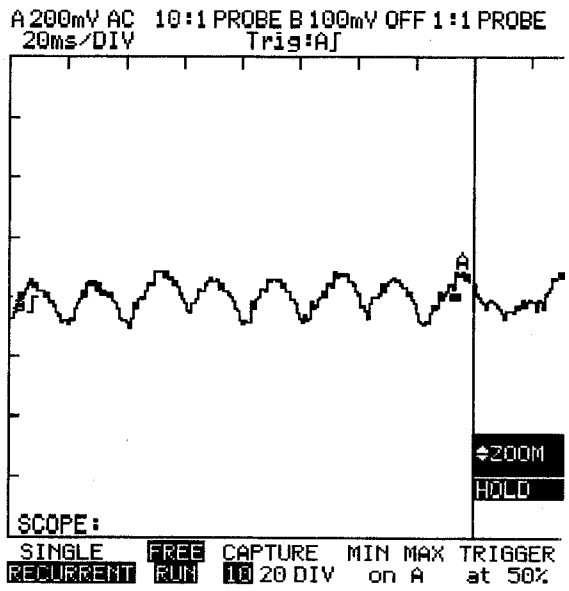

Alternator Ripple Voltage

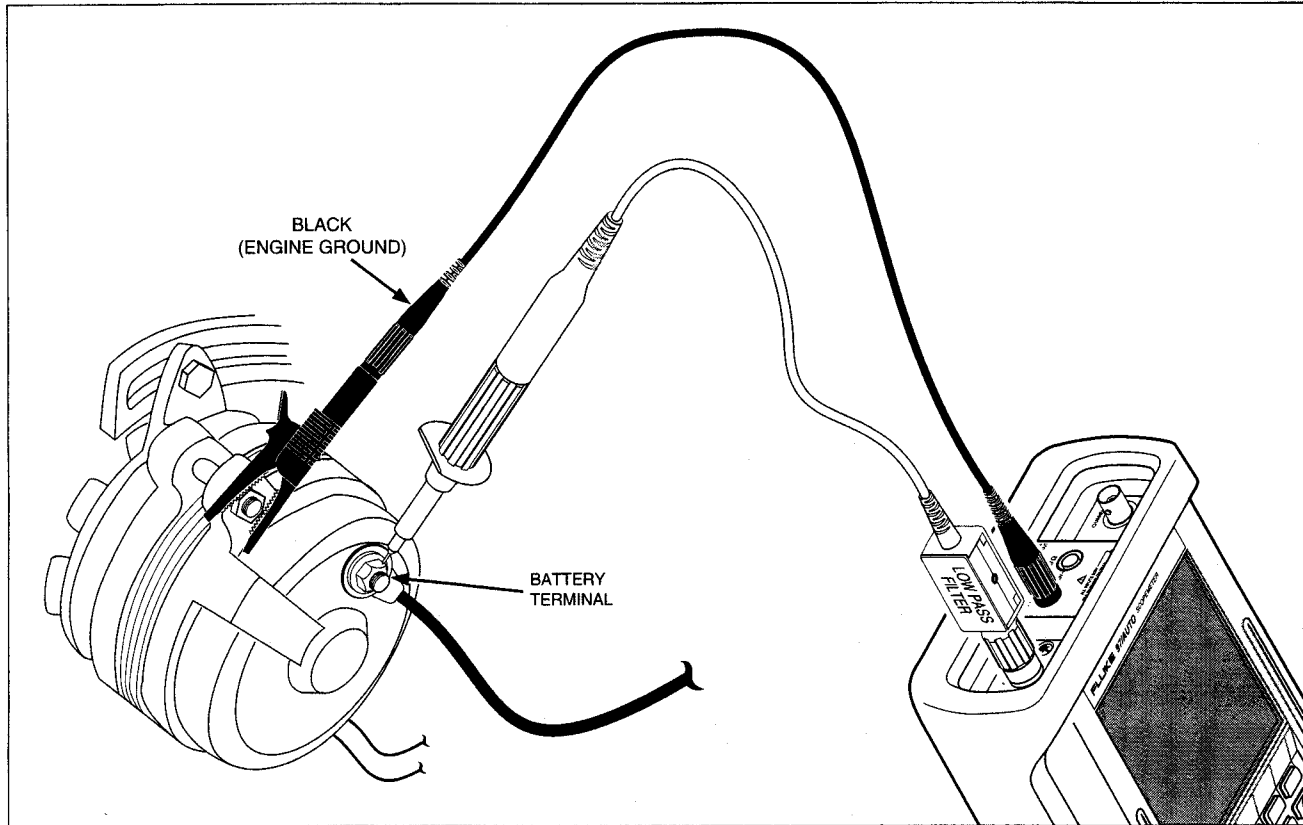

Figure 5-1. Testing Alternator Ripple Voltage



CLAMPING/SUPPRESSION DIODES

When an electromagnetically controlled device is deenergized, a voltage spike can be induced by the collapse of the magnetic field. Clamping (or suppression) diodes are used to filter out these inductive spikes. Horn circuits, relays, blower motors, and air conditioning clutches are examples of devices that use diodes for this purpose.

A faulty diode can cause induced noise, often detectable over a car's audio system. These noise spikes are seen on ScopeMeter as large overshoots when the waveform transitions from one level to another. They can also cause interference in other more sensitive areas of the car's sensor and control system.

WARNING

TO AVOID ELECTRICAL SHOCK, USE BACK PROBE PINS ONLY IN LOW VOLTAGE CIRCUITS. BACK PROBE PINS MUST NOT BE USED WHERE VOLTAGES GREATER THAN 30V AC OR 60V DC CAN BE ENCOUNTERED.

CAUTION

To avoid fire or damage to electrical circuits, ensure that back probe pins make electrical contact only with the low voltage test point. Do not allow back probe pins to contact any other conductive surface.

97/AUTO

Users Manual

① Connect ScopeMeter to the air conditioning compressor as shown. Use back probe pins to gain access to the connection. Use Channel A for all setups and connections.

② **ON**
OFF

③ **SCOPE** **SINGLE** **FREE** **CAPTURE**
RECURRENT **RUN** **10** **20** **DIV**
SFTKEY **SFTKEY** **SFTKEY**
1 **2** **3**

④ **LCD** **PROBE** **CAL** **↕**
SFTKEY **2**

Use ↕ For
CAL&ADJUST:
Channel A
•1:1
•10:1
•100:1
•1000:1
•AC ADJUST
•DC CAL
Channel B
•1:1
•10:1
•100:1
•1000:1
•AC ADJUST
•DC CAL

ENTER:
SFTKEY
5

⑤ **CHANNEL A**
AC DC **DC**
GROUND

⑥ **mV** **5V/DIV** **s TIME ns** **50µs/DIV**
v

⑦ **TRIGGER** **DELAY** **↕** **+SLOPE**
SFTKEY **SFTKEY**
4 **2**

Use ↕ For
DELAY:
↕select:
•TIME DELAY
Mode (use A)
•N-CYCLE
•EVENTS

ENTER:
SFTKEY
5

⑧ **↕** **↕DELAY**
-3

TRIGGER **LEVEL**

⑨ **SFTKEY** **↕LEVEL**
3 **-1.50V**

⑩ **HOLD** **NOTRIG**
RUN

⑪ Start engine and cycle air conditioning compressor several times to obtain a good waveform.

⑫ To reset ScopeMeter:

HOLD **NOTRIG**
RUN

⑬ Use cursors to measure the amount of over shoot present. If no signal is present, connect the probe to the other wire leading to the air conditioner clutch.

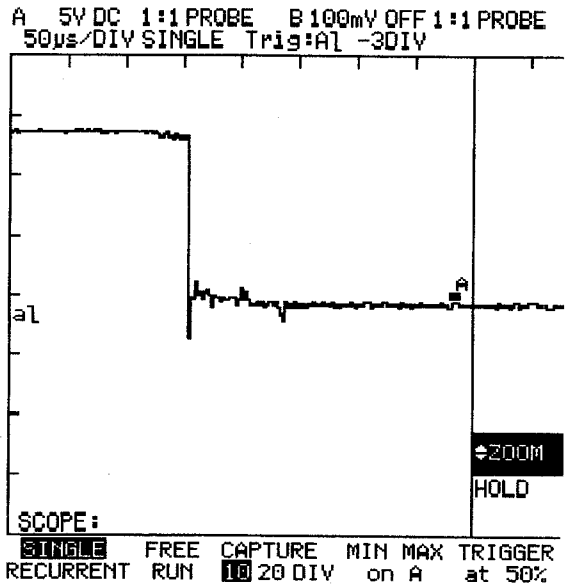

Clamping Diode Test

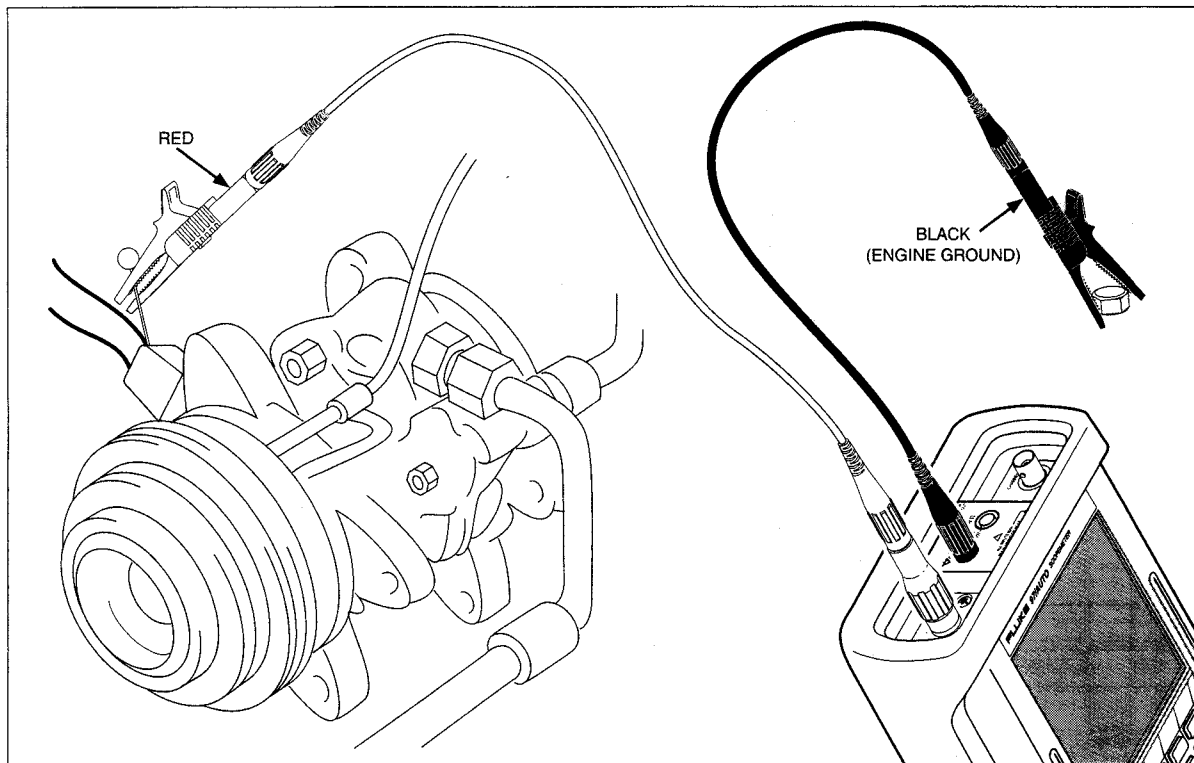

Figure 5-2. Testing a Clamping Diode (Air Conditioner Clutch)

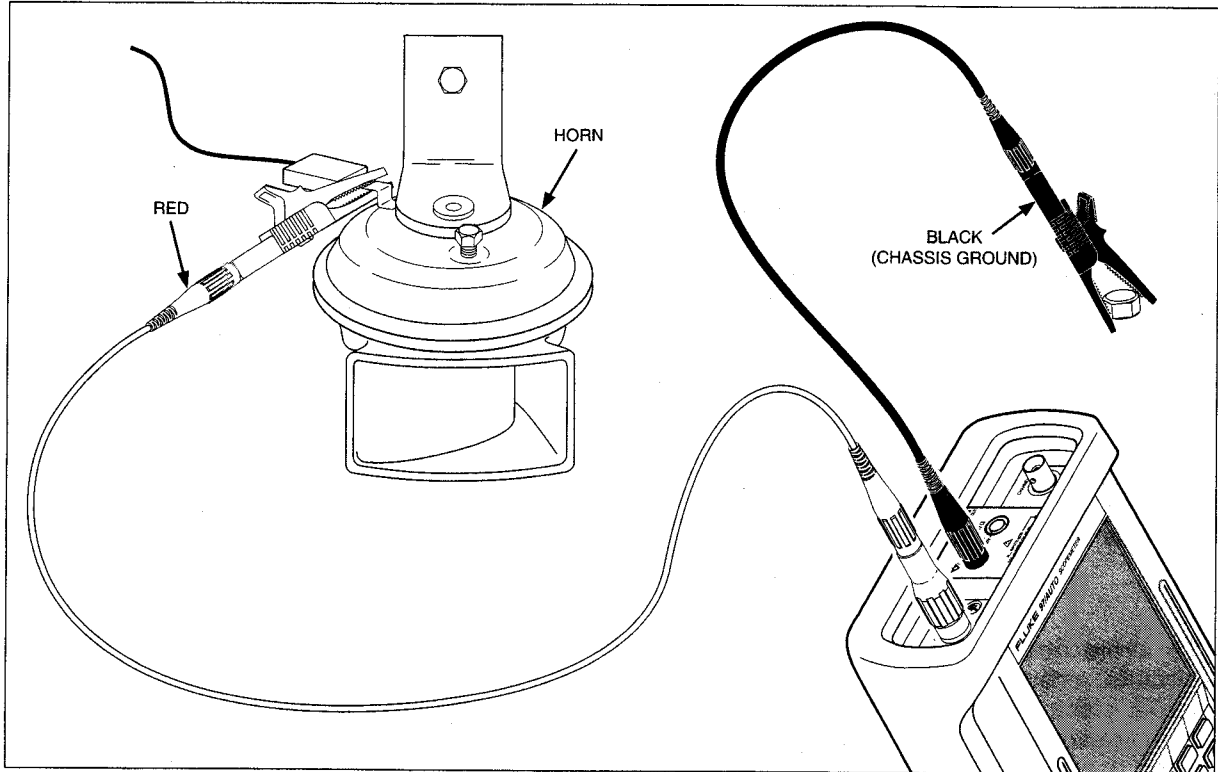

Figure 5-3. Testing a Clamping Diode (Horn)

VARIABLE POSITION (POTENTIOMETER) SENSORS

Variable Position Sensors provide a dc voltage level that changes as the arm on a variable resistor (potentiometer) is moved. The changing dc voltage is used as an input to the electronic control unit.

Sensor arm movement can result from changes in the throttle position (Throttle Position Sensors), the amount of air being used by the engine (Mass Air Flow - MAF Meters,) or the height of the vehicle (Vehicle Height Sensors).

WARNING

TO AVOID ELECTRICAL SHOCK, USE BACK PROBE PINS ONLY IN LOW VOLTAGE CIRCUITS. BACK PROBE PINS MUST NOT BE USED WHERE VOLTAGES GREATER THAN 30V AC OR 60V DC CAN BE ENCOUNTERED.

CAUTION

To avoid fire or damage to electrical circuits, ensure that back probe pins make electrical contact only with the low voltage test point. Do not allow back probe pins to contact any other conductive surface.

Test A: (ENGINE OFF, SENSOR DISCONNECTED).

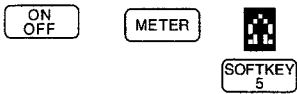
- 1 Connect ScopeMeter to the sensor as shown for out-of-circuit measurements in Figure 5-4(A) or Figure 5-5.
- 2 

ON
OFF

METER

SOFTKEY
5
- 3 Sweep the sensor to its maximum position and note what range the meter upranges to.
- 4 

Reset range to the maximum previously stored.
(Usually 30 k Ω .)
- 5 

RECORD
- 6 For each reading, sweep the sensor from closed, to full open, and back to closed.



Test B: (KEY ON, ENGINE OFF, SENSOR CONNECTED).

Connect ScopeMeter to the sensor for in-circuit measurements. See Figure 5-4(B) or Figure 5-6. Use a backprobe pin, breakout box, or jumper wire for the connection to Channel A.

- 1
- 2
- 3 CHANNEL A GND (Move the ground trace down to the second division from the bottom of the display.)
- 4 DC
- 5 1V/DIV 200ms/DIV
- 6 ENTER:
- 7

- 8
- 9
- 10 Turn key on, do not start engine.
- 11 To obtain the waveform shown, sweep the sensor from closed, to full open, and back to closed.
- 12

A 1V DC 1:1 PROBE B 100mV OFF 1:1 PROBE
200ms/DIV SINGLE Trig:AJ -3DIV

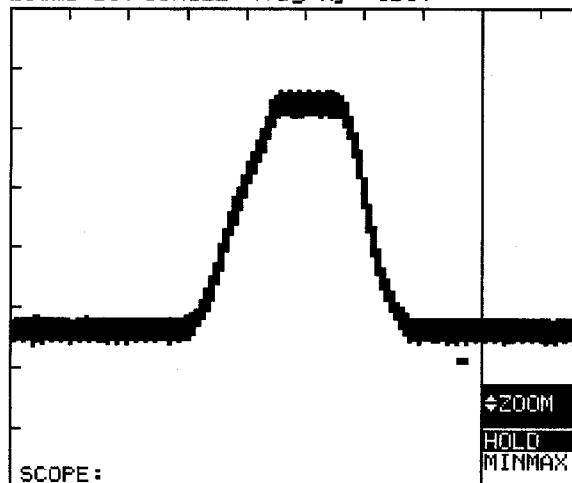

SCOPE:
SINGLE FREE CAPTURE MIN MAX TRIGGER
RECURRENT RUN 10 20 DIV on A at 50%

Throttle Position Sensor Test

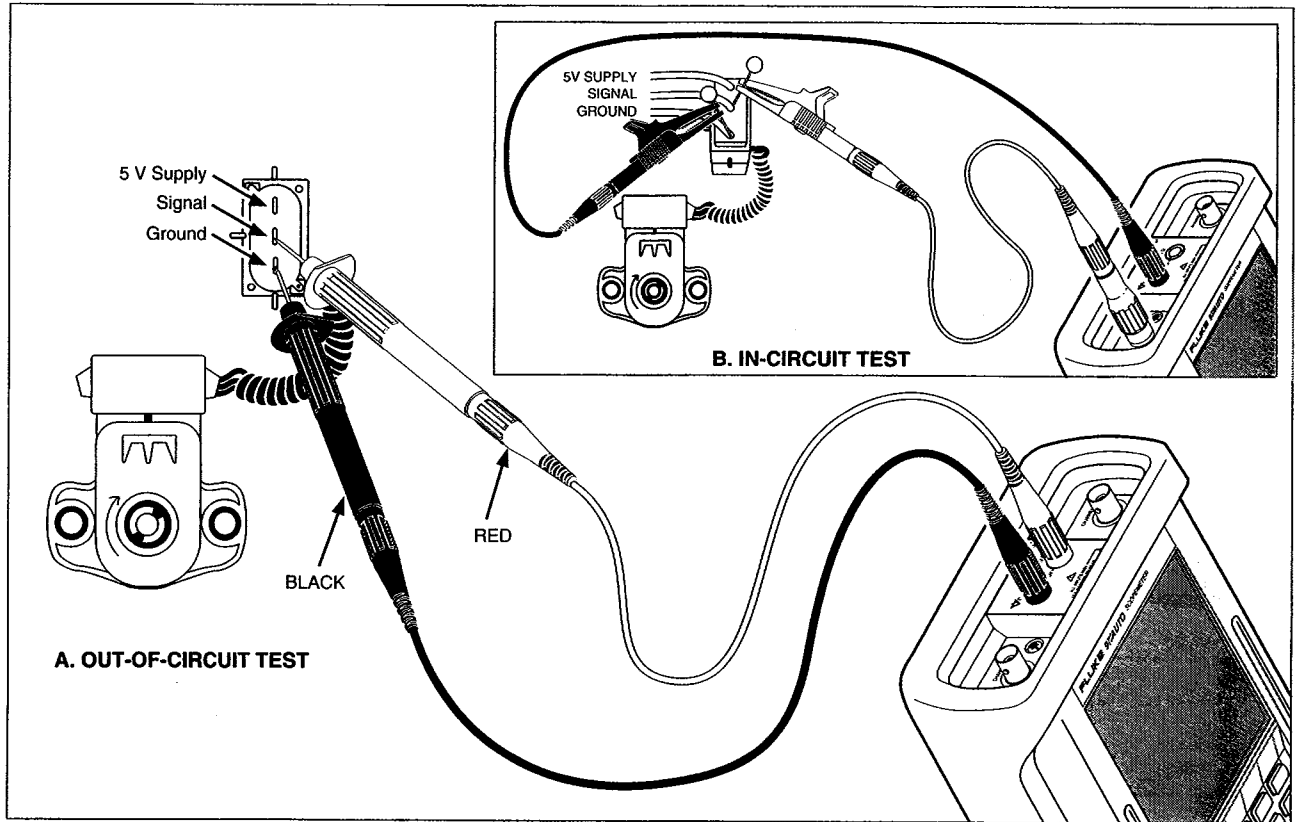

Figure 5-4. Testing a Throttle Position Sensor (TPS)

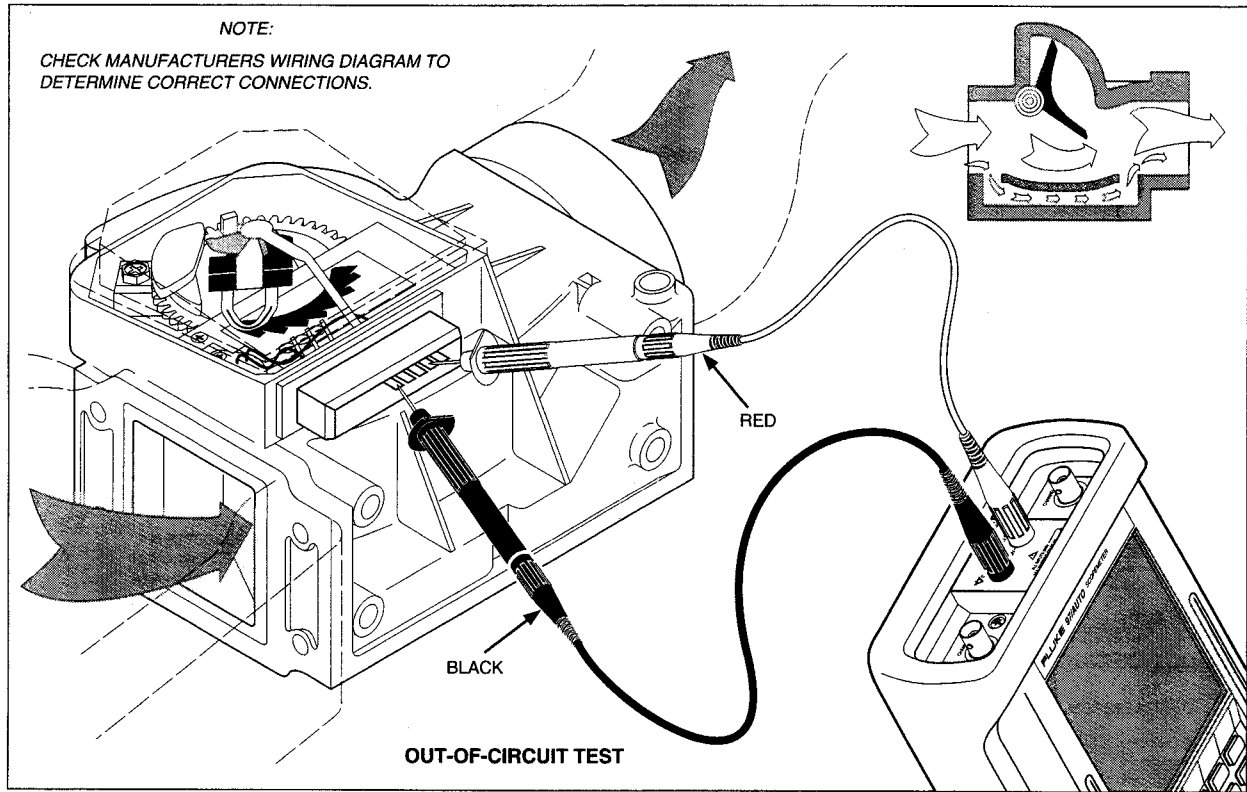

Figure 5-5. Testing an Air Flow Meter

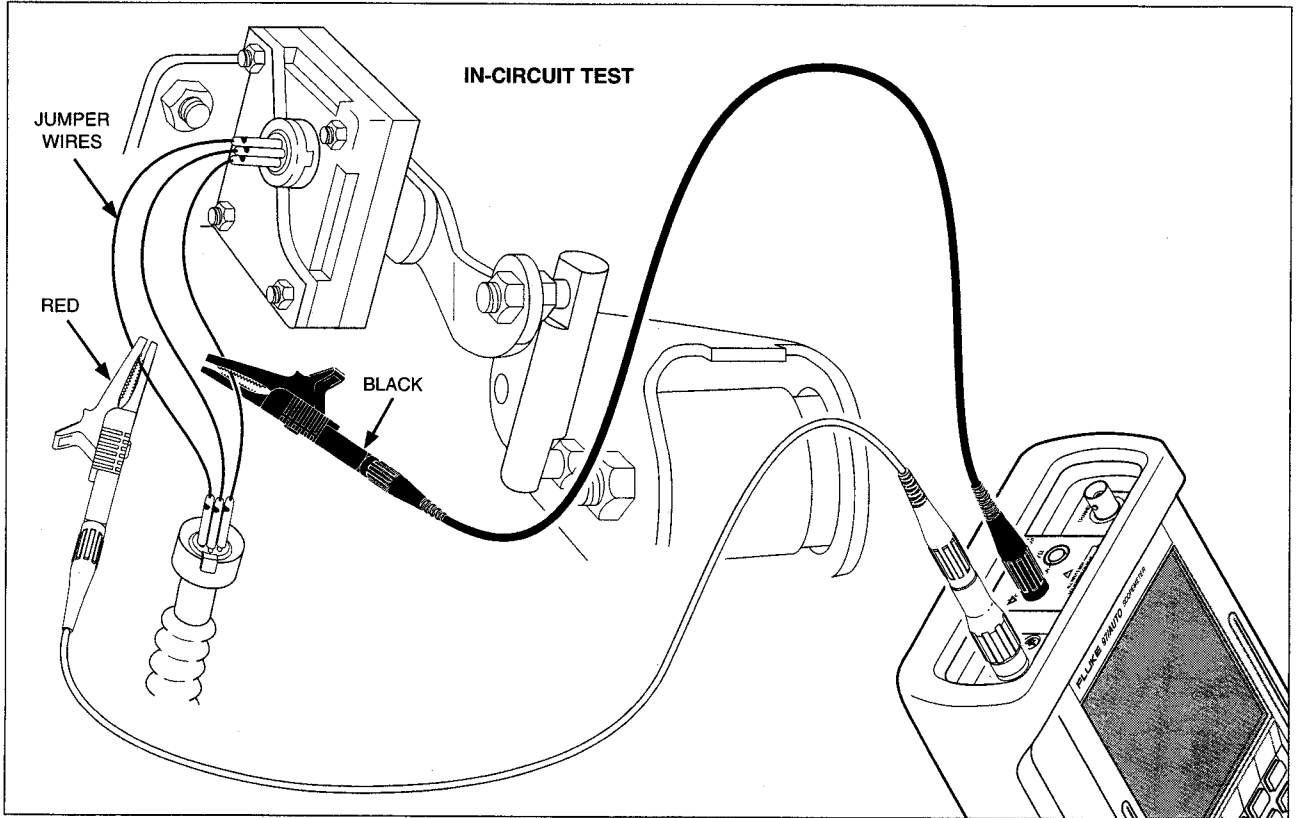
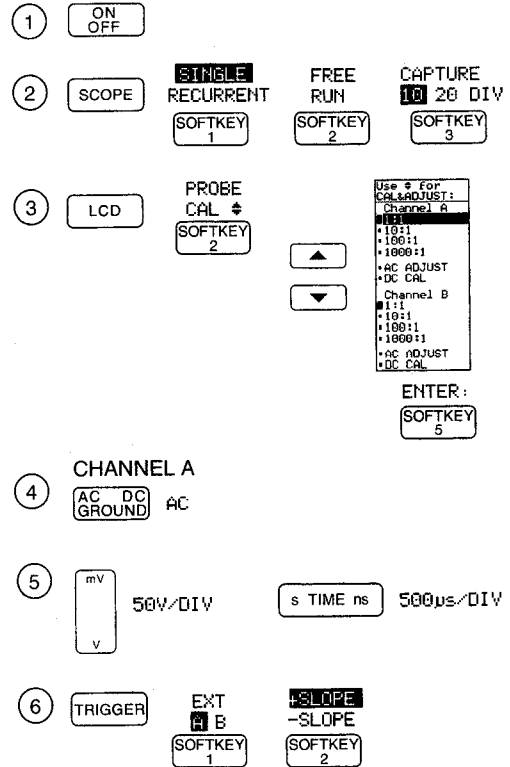

Figure 5-6. Testing a Vehicle Height Sensor

KNOCK SENSOR (PIEZO CRYSTAL)

A knock sensor operates as a piezoelectric device, where a special type of crystal generates a voltage when subjected to mechanical stress. The stress is provided by engine knocking. The output voltage is used to adjust ignition timing to optimize engine performance.





7 DELAY
 SOFTKEY 4

Use ↕ for DELAY:
 ↕ Select: TIME DELAY
 Mode (Use A):
 *N-CYCLE
 *EVENTS

ENTER:
 SOFTKEY 5



↕ DELAY
 -2

8 TRIGGER LEVEL
 SOFTKEY 3

↕ LEVEL
 +48.0V



9 HOLD RUN NOTRIG

10 Tap the knock sensor with a metal extension and look for a waveform similar to that shown.

11 To reset ScopeMeter for further tests:

HOLD RUN NOTRIG

A 50V AC 1:1 PROBE B 10mV OFF 1:1 PROBE
 500µs/DIV SINGLE Trig:A] -2DIV

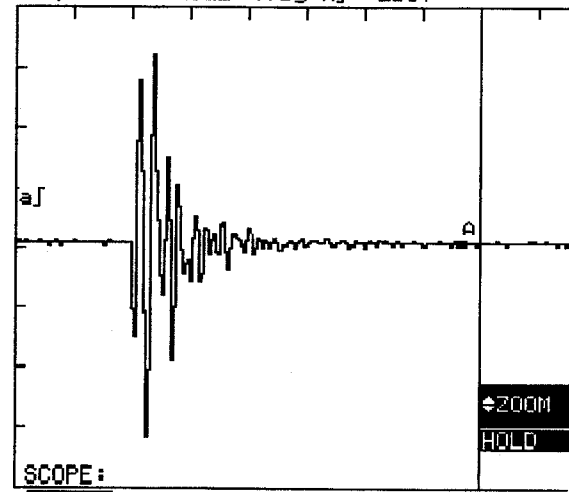

SCOPE:
 SINGLE FREE CAPTURE MIN MAX TRIGGER
 RECURRENT RUN 10 20 DIV on A at 50%

Knock Sensor Test

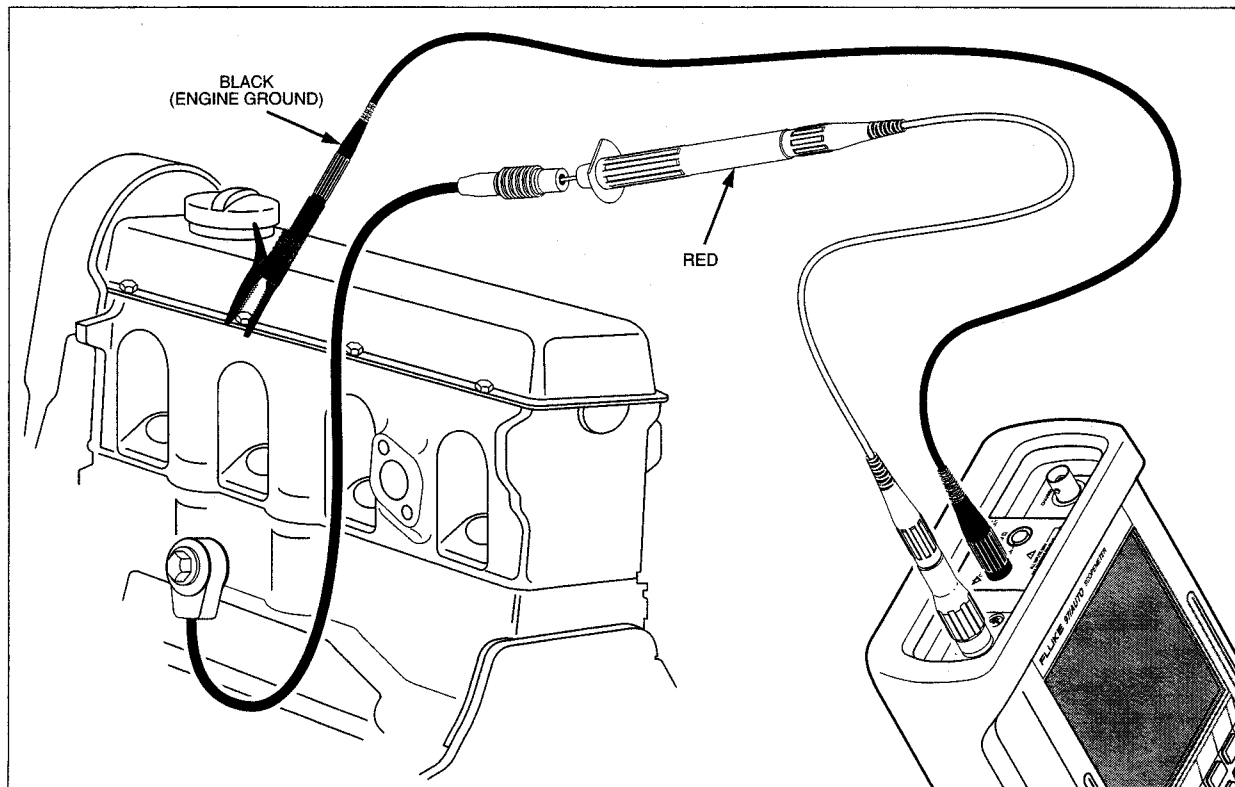

Figure 5-7. Testing a Knock Sensor



FUEL INJECTOR PULSE WIDTH

Standard fuel injectors use Saturated Switch Drivers. A single pulse is used to activate the injector.

Throttle Body Injectors (also called "Peak and Hold") are activated by an initial pulse. A second smaller pulse is then applied to hold the injector activated. Since the initial pulse is about four times the second pulse, this type of injector is often called a "4 to 1".

WARNING

TO AVOID ELECTRICAL SHOCK, USE BACK PROBE PINS ONLY IN LOW VOLTAGE CIRCUITS. BACK PROBE PINS MUST NOT BE USED WHERE VOLTAGES GREATER THAN 30V AC OR 60V DC CAN BE ENCOUNTERED.

CAUTION

To avoid fire or damage to electrical circuits, ensure that back probe pins make electrical contact only with the low voltage test point. Do not allow back probe pins to contact any other conductive surface.

- 1 Connect ScopeMeter to the switching side of the fuel injector as shown.
- 2
- 3 SINGLE RECURRENT CAPTURE 10 20 DIV
- 4 PROBE CAL \updownarrow ENTER:
- 5 CHANNEL A GND (Move the ground trace down to the first division on the display.)
- 6 DC
- 7 10V/DIV 2ms/DIV

8 TRIGGER DELAY
SOFTKEY 4

Use \uparrow For DELAY!
select!
TIME DELAY
Mode (use A)
• N-CYCLE
• EVENTS

ENTER:
SOFTKEY 5

9 \uparrow DELAY
 \downarrow -4 TRIGGER LEVEL
SOFTKEY 3

10 \uparrow LEVEL
 \downarrow +8.00V

11 +SLOPE
-SLOPE
SOFTKEY 2

Start engine and check for the display shown

A 10V DC 1:1 PROBE B 20mV OFF 1:1 PROBE
2ms/DIV Trig:A1 -4DIV

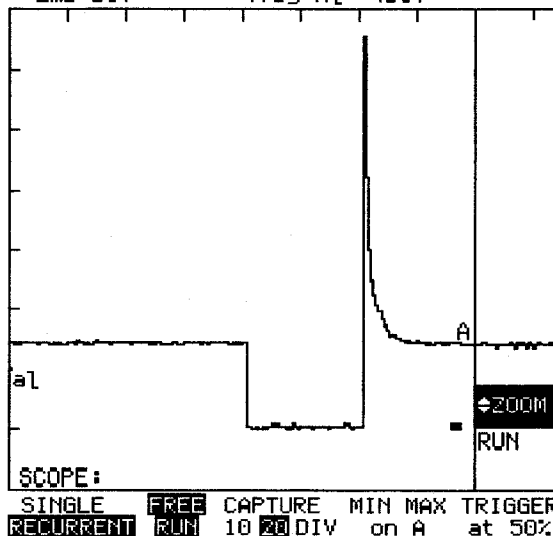

Fuel Injector Test

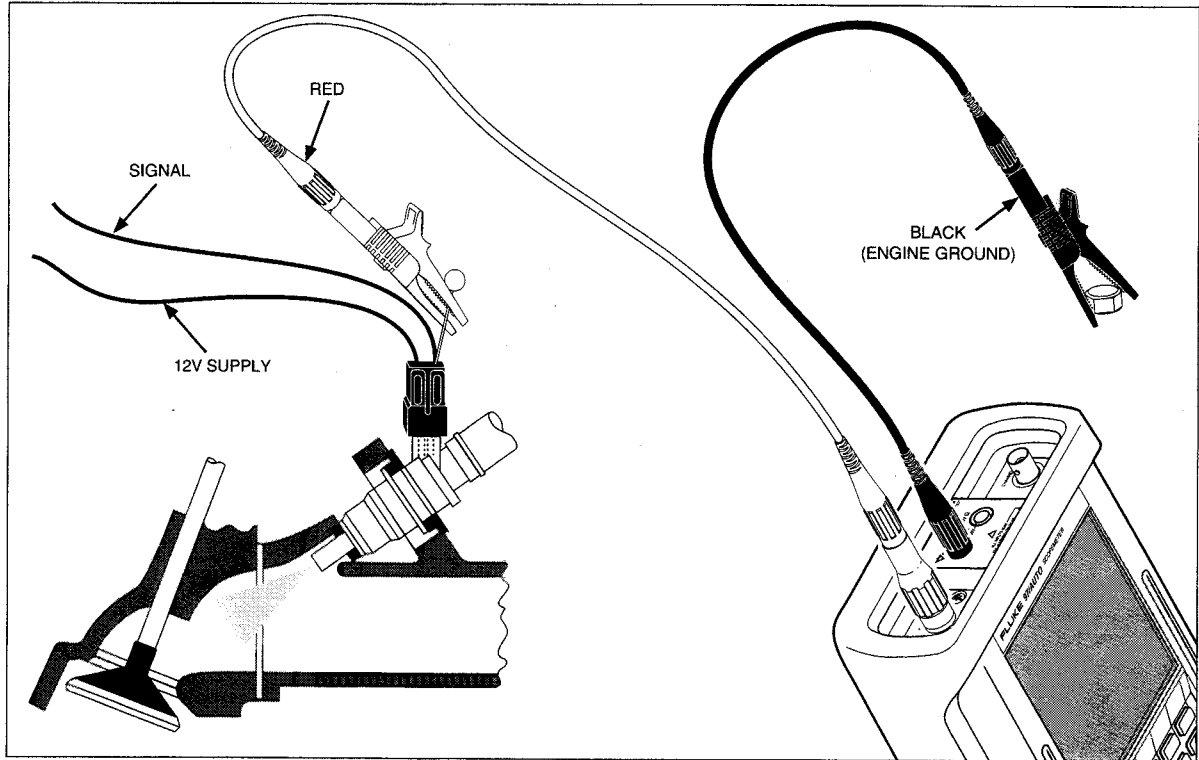

Figure 5-8. Testing a Fuel Injector

OXYGEN SENSORS

An Oxygen Sensor provides an output voltage that represents the amount of oxygen in the exhaust stream. A high output voltage results from a rich condition. A low output voltage means a lean condition. The output voltage is used by the control system to adjust the amount of fuel delivered to the engine (by controlling injector on time or by controlling the mixture control solenoid in carbureted engines.)

The Low Pass Filter Probe and PM9085 Hook Clip used here are available with the K97A Accessory Kit. Contact your tool distributor for more information.

WARNING

TO AVOID ELECTRICAL SHOCK, USE BACK PROBE PINS ONLY IN LOW VOLTAGE CIRCUITS. BACK PROBE PINS MUST NOT BE USED WHERE VOLTAGES GREATER THAN 30V AC OR 60V DC CAN BE ENCOUNTERED.

CAUTION

To avoid fire or damage to electrical circuits, ensure that back probe pins make electrical contact only with the low voltage test point. Do not allow back probe pins to contact any other conductive surface.



- 1 Connect ScopeMeter to the sensor as shown. (use a backprobe pin). Connect the Low Pass Filter Probe to Channel A.

Scope Mode Test

- 2 **ON OFF**

- 3 **LCD**

PROBE
CAL \updownarrow
SOFTKEY
2



```
Use # for
CAL&ADJUST:
Channel A
*1:1
*100:1
*1000:1
*AC ADJUST
*DC CAL
Channel B
*1:1
*10:1
*100:1
*1000:1
*AC ADJUST
*DC CAL
```

ENTER:
SOFTKEY
5

- 4 **SCOPE**

SINGLE
RECURRENT
SOFTKEY
1

FREE
RUN
SOFTKEY
2

CAPTURE
10 20 DIV
SOFTKEY
3

- 5 CHANNEL A
AC DC
GROUND DC

- 6 **mV**
200mV/DIV
v

s TIME ns 200ms/DIV

- 7 Start engine, run at fast idle for a few minutes to heat the O₂ and check for the display shown.

- 8 **TRIGGER** **TRIGGER LEVEL**
SOFTKEY
3

Use arrow keys to adjust trigger level, if necessary to stabilize display.

Meter Mode Test

- 1 **ON OFF**

- 2 **METER**

V
SOFTKEY
2

- 3 Start engine, run at fast idle for a few minutes to heat the O₂ sensor.

- 4 **▲**
▼

Set meter to 3V range.

- 5 **RECORD**

Check for the display shown.

A 200mV DC 10:1 PROBE B 20mV OFF 1:1 PROBE
200ms/DIV Trig:AJ

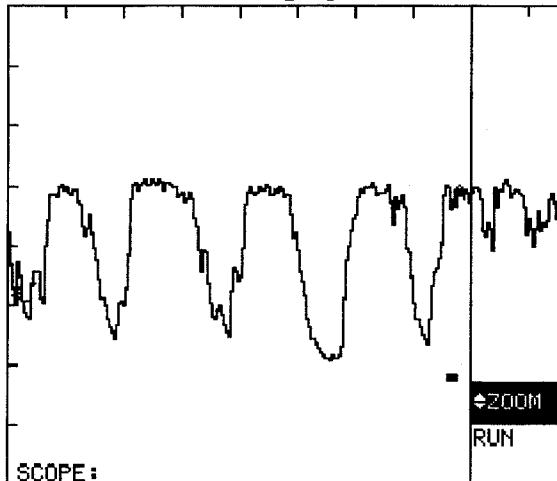

SCOPE:
SINGLE **FREE** CAPTURE MIN MAX TRIGGER
RECURRENT **RUN** 10 20 DIV on A at 50%

V DC
+0.658 NOW

CHANNEL A

+0.757 MAX 000hr 00:21

+0.427 AVG 000hr 00:44

+0.063 MIN 000hr 00:28

MANUAL
RANGE
10:1
PROBE
3V
30V
300V
3kV
↕RANGE

5ms/DIV AUTO 0 Hz OL 1/1+
<= CHANNEL A => <=== EXT TRIGGER IN ===>

V_{rms} mV

Oxygen Sensor Scope Mode Test

Oxygen Sensor Meter Mode Test

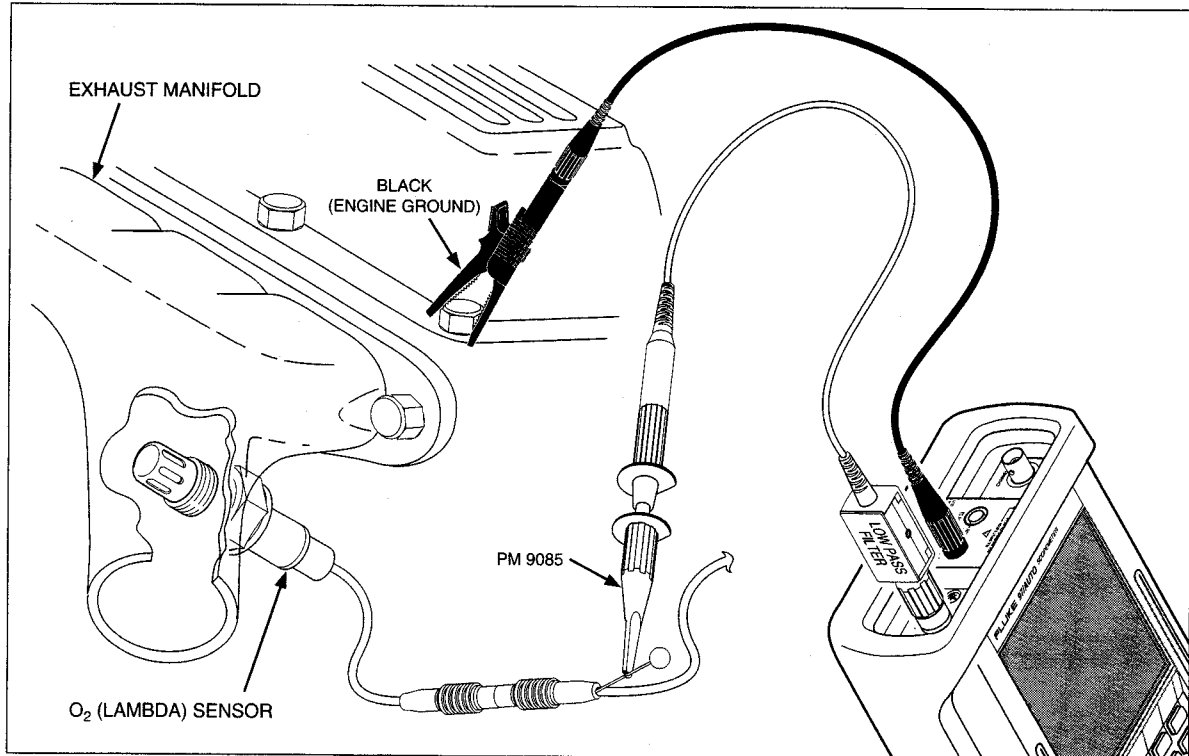

Figure 5-9. Testing an Oxygen Sensor

VARIABLE RELUCTANCE SENSORS (MAGNETIC)

Variable Reluctance Sensors do not require a separate power connection. Small signal voltages are induced as the teeth of a trigger wheel pass through the magnetic field of a stationary magnet and coil. The trigger wheel is made of a low magnetic reluctance steel.

Typically, a Variable Reluctance Sensor has two connecting wires for the stationary magnet's coil. Crankshaft Position Sensor (CPS), ABS Wheel Speed Sensor, and Vehicle Speed Sensor (VSS) are examples of Variable Reluctance Sensors.

① Connect ScopeMeter to the sensor as shown.

② **ON**
OFF

③ **SCOPE** **SINGLE** **FREE** **CAPTURE**
 RECURRENT **RUN** **10 20 DIV**
 SOFTKEY **SOFTKEY** **SOFTKEY**
 1 **2** **3**

④ **LCD** **PROBE**
 CAL **↕**
 SOFTKEY
 2

Use ← for
CAL & ADJUST:

Channel A

1:1

• 10:1

• 100:1

• 1000:1

• AC ADJUST

• DC CAL

Channel B

1:1

• 10:1

• 100:1

• 1000:1

• AC ADJUST

• DC CAL

ENTER:
SOFTKEY
5

⑤ **CHANNEL A**
AC DC **AC**
GROUND

⑥ **mV** **500mV/DIV** **s TIME ns** **20ms/DIV**
v

(Choose a timebase to display 2 or 3 oscillations.)

⑦ **TRIGGER** **DELAY**
 ZERO
 SOFTKEY
 5

8 Start engine or rotate reluctor.

9 **SCOPE** **TRIGGER**
at 50%
SOFTKEY
5

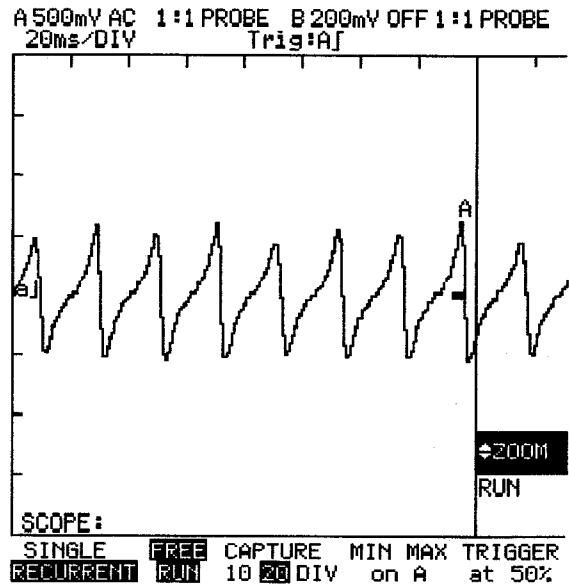

Variable Reluctance (Magnetic) Sensor Test

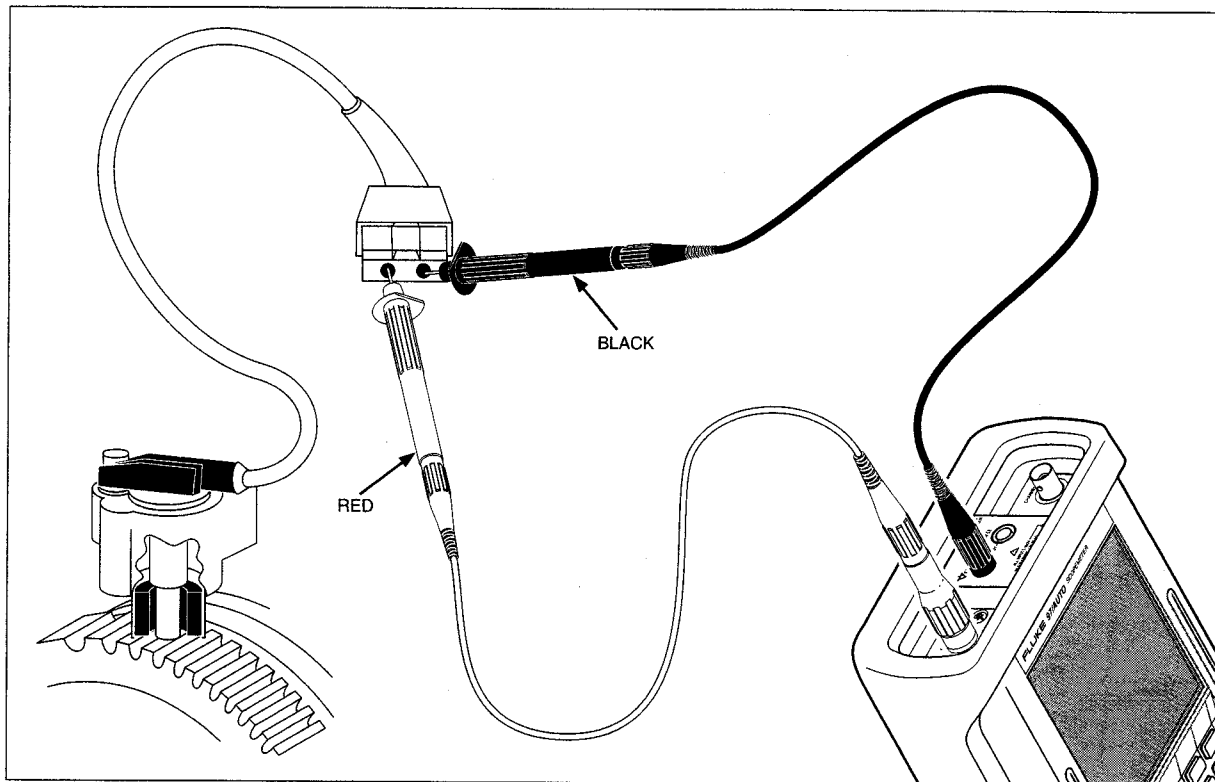

Figure 5-10. Testing a Crankshaft Position Sensor

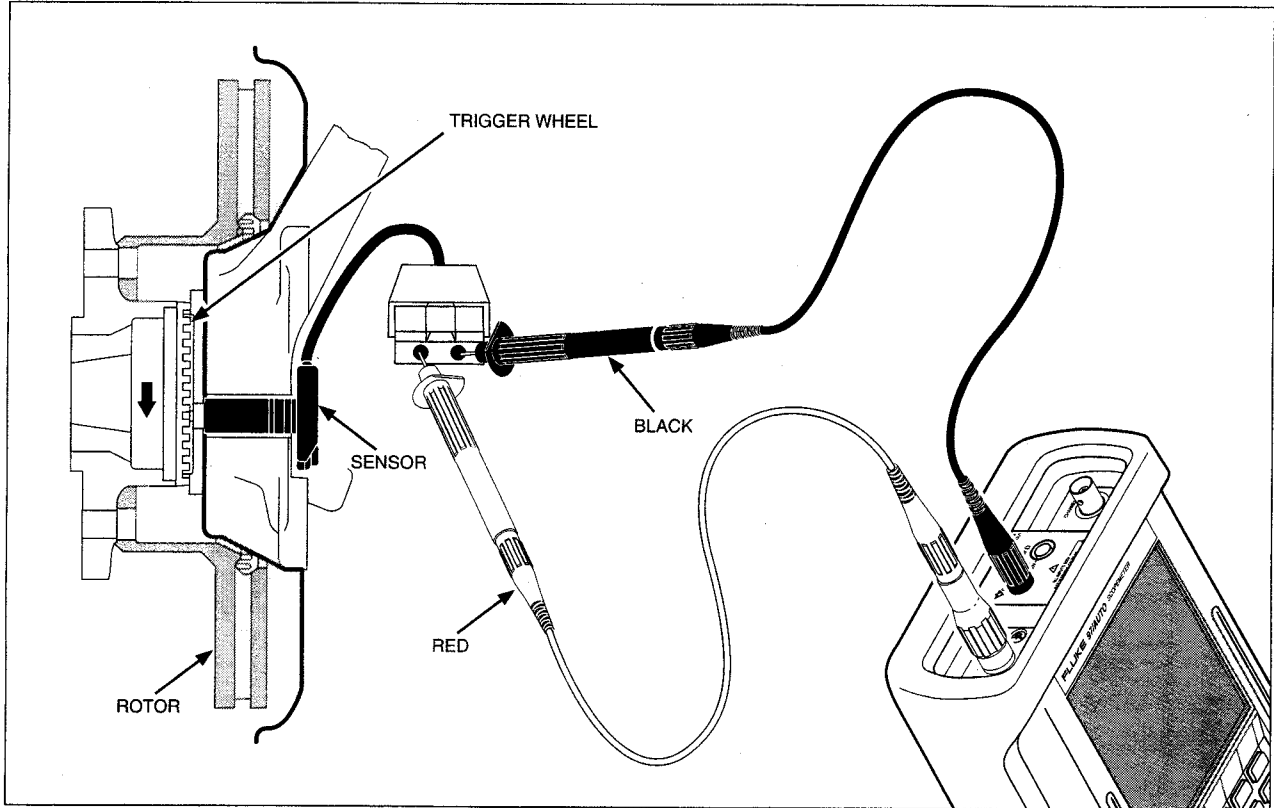

Figure 5-11. Testing a Wheel Speed Sensor

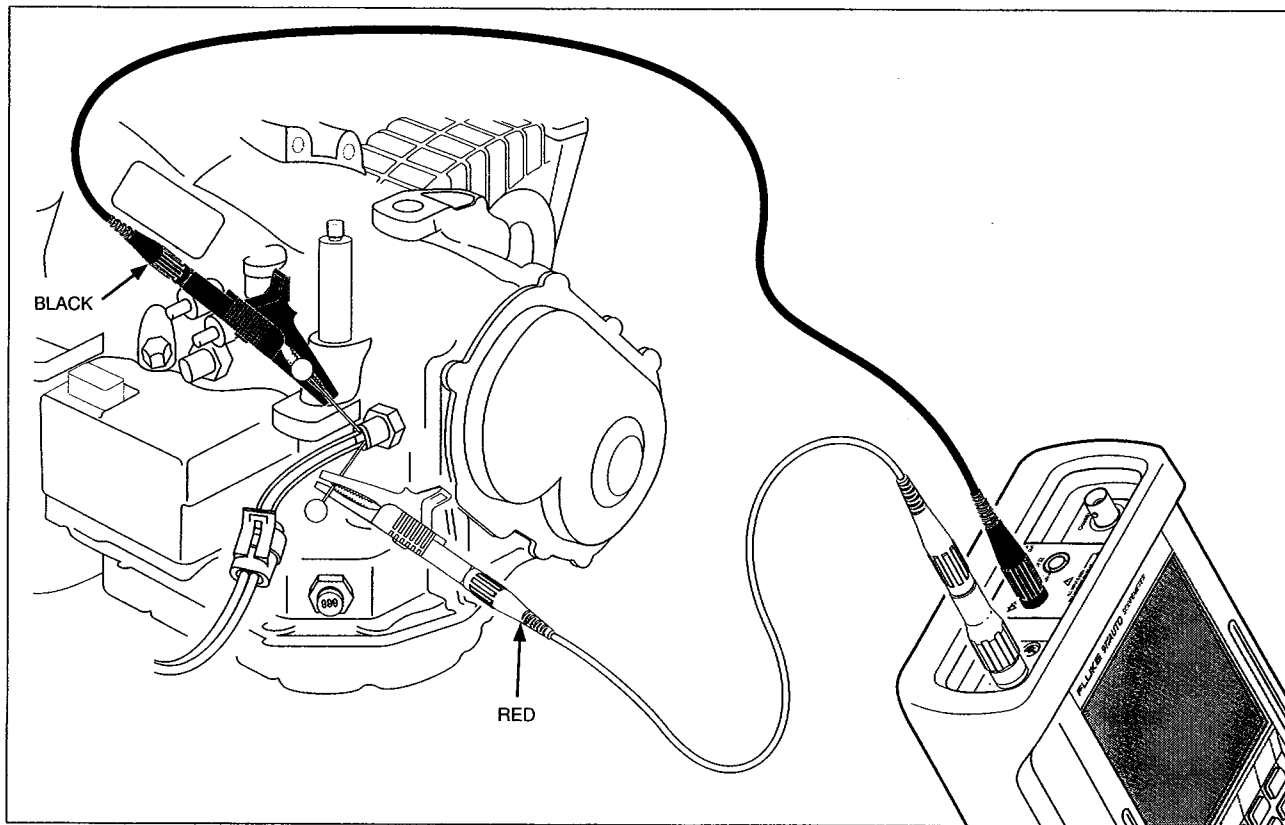

Figure 5-12. Testing a Vehicle Speed Sensor

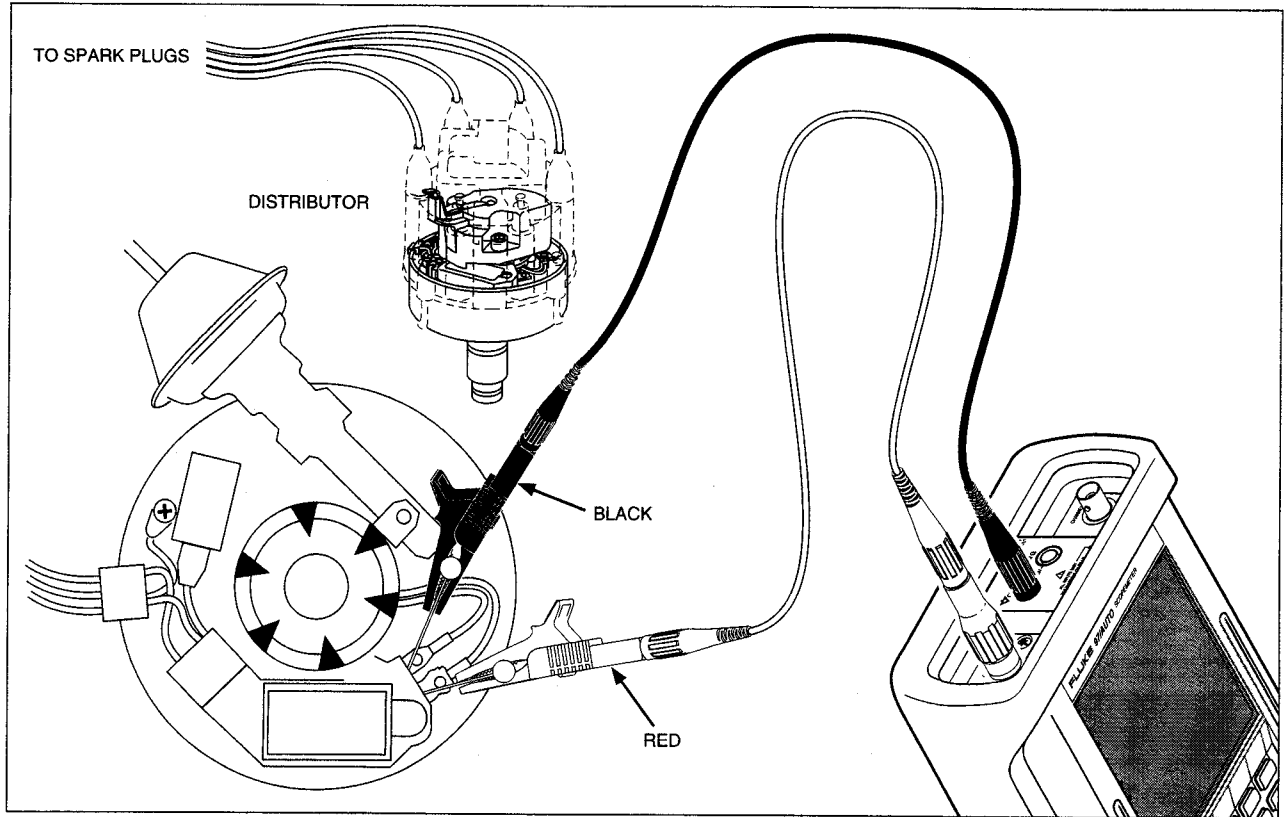

Figure 5-13. Testing a Magnetic Distributor

HALL EFFECT SENSORS

In a Hall Effect Sensor, a current is passed through a semiconductor that is positioned close to a varying magnetic field. These variations can be caused by the turning of a crankshaft or the rotation of a distributor shaft.







The resulting voltage variations can then be used as a reference signal for other systems. Hall Effect Sensors are used in Crankshaft Position Sensors and Distributors.







WARNING

TO AVOID ELECTRICAL SHOCK, USE BACK PROBE PINS ONLY IN LOW VOLTAGE CIRCUITS. BACK PROBE PINS MUST NOT BE USED WHERE VOLTAGES GREATER THAN 30V AC OR 60V DC CAN BE ENCOUNTERED.

CAUTION

To avoid fire or damage to electrical circuits, ensure that back probe pins make electrical contact only with the low voltage test point. Do not allow back probe pins to contact any other conductive surface.

- ① Connect ScopeMeter to the sensor as shown.
- ② 
- ③  SINGLE RECURRENT SOFTKEY 1 FREE RUN SOFTKEY 2 CAPTURE 10 20 DIV SOFTKEY 3
- ④  LCD PROBE CAL SOFTKEY 2    ENTER: SOFTKEY 5

Use ↵ for CAL ADJUST:
 Channel A
 * 10:1
 * 100:1
 * 1000:1
 * AC ADJUST
 * DC CAL
 Channel B
 * 1:1
 * 10:1
 * 100:1
 * 1000:1
 * AC ADJUST
 * DC CAL
- ⑤ CHANNEL A   DC 
- ⑥  5V/DIV  TIME ns 10ms/DIV
- ⑦ Start engine.
- ⑧  TRIGGER SOFTKEY 5
- ⑨ Check for the first screen.



10 CURSOR DATA FUNCTION

SOFTKEY 2

▲

▼

```

Use ↕ For
FUNCTION
*VOLT at -1-
*dt
*1/dt
*TRIG to -1-
*RMS
*MEAN
*PEAK/PEAK
*MAX PEAK
*MIN PEAK
*FREQUENCY
*RISE TIME
OFF
    
```

ENTER: SOFTKEY 5

CURSOR
SOFTKEY 3

11 HOLD RUN HOLD

12 <CURSOR> <CURSOR>
-1- -2--

Move the cursors to measure one cycle.

13 To measure duty cycle:

NORMAL
△ ■

SOFTKEY 5 <CURSOR>
-2--

Move cursor 2 to bracket 1/2 cycle, and read dt as a percentage. See the second screen. Refer to Section 8F, Duty Cycle (in percent) to Dwell (in degrees) Conversion.

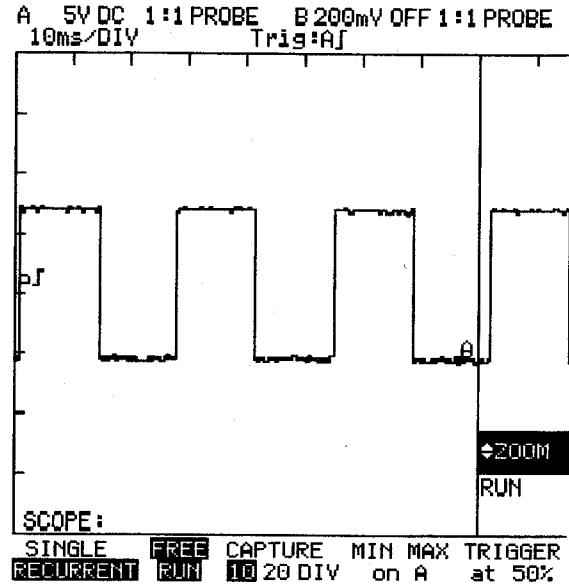

Hall Effect Test

A 5V DC 1:1 PROBE B 200mV OFF 1:1 PROBE
10ms/DIV Trig:AJ

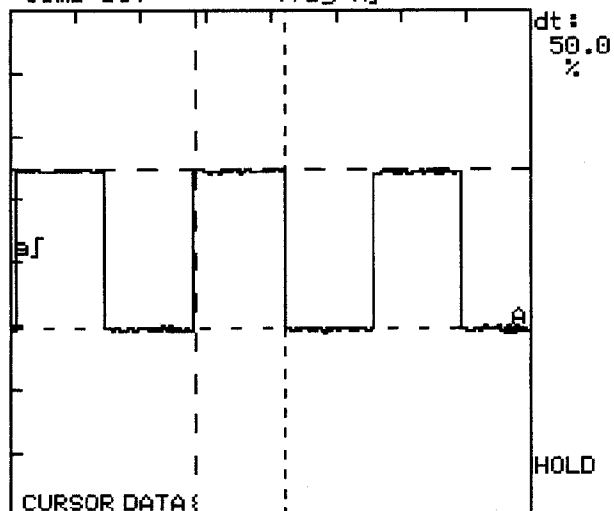

FUNCTION MARK on A NORMAL
CURSOR NONE

Hall Effect Duty Cycle Test

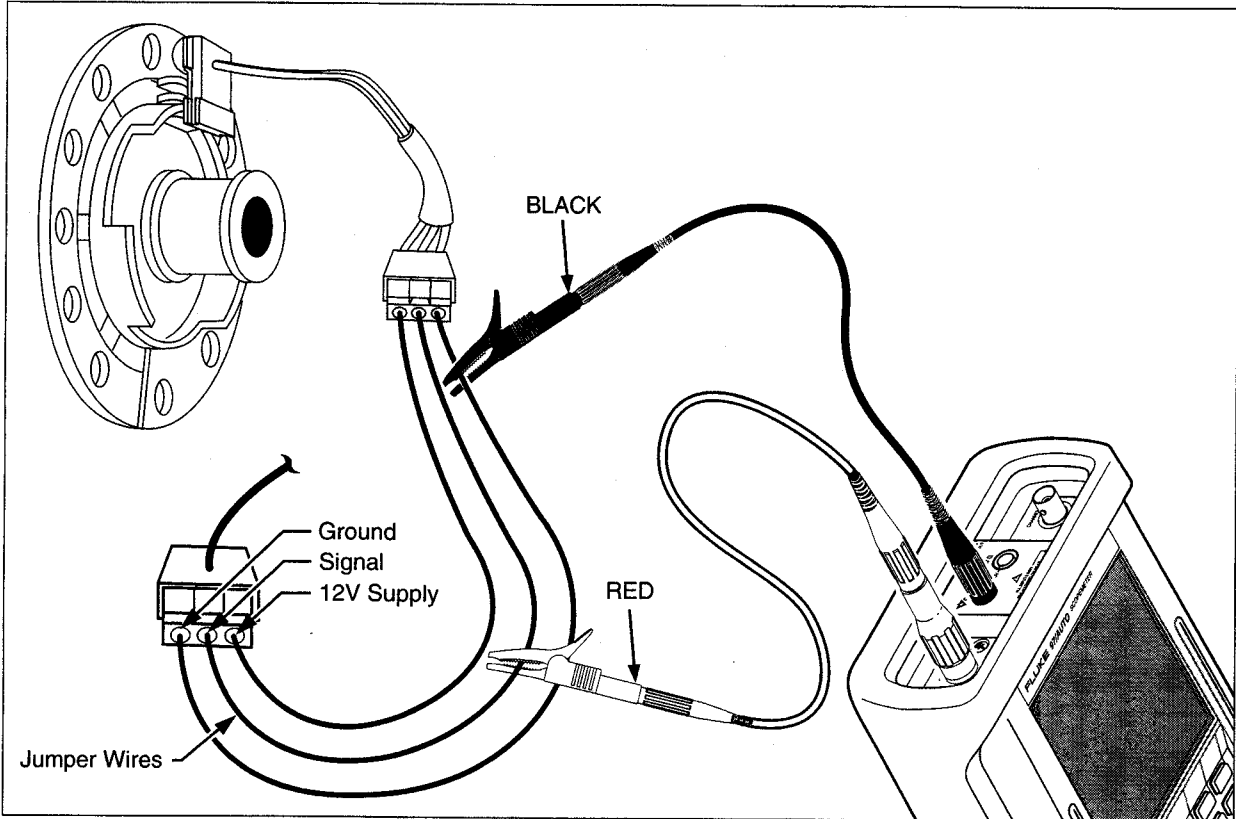

Figure 5-14. Testing a Hall Effect Sensor

ELECTRICAL INTERFERENCE (RFI OR EMI ON GROUND OR FEED)

Radio Frequency Interference (RFI) or Electromagnetic Interference (EMI) can be present on virtually any part of the ground or feed system. This is high-frequency interference and will normally be detectable as an audible condition. It can play havoc with both sensor feedback and computer control signals.

Shielding protects some circuits from problems with RFI and EMI. RFI or EMI can still appear in unprotected or unprotectable areas of a car's electronic monitoring and control system. Correcting the source of the interference is the best cure for RFI and EMI.

WARNING

TO AVOID ELECTRICAL SHOCK, USE BACK PROBE PINS ONLY IN LOW VOLTAGE CIRCUITS. BACK PROBE PINS MUST NOT BE USED WHERE VOLTAGES GREATER THAN 30V AC OR 60V DC CAN BE ENCOUNTERED.

CAUTION

To avoid fire or damage to electrical circuits, ensure that back probe pins make electrical contact only with the low voltage test point. Do not allow back probe pins to contact any other conductive surface.



- 1 Connect ScopeMeter as shown.
- 2 **ON**
OFF
- 3 **SCOPE** **SINGLE** **FREE** **CAPTURE**
 RECURRENT **RUN** **10 20 DIV**
 SOFTKEY 1 **SOFTKEY 2** **SOFTKEY 3**
- 4 **CHANNEL A**
 AC DC **AC**
 GROUND
- 5 **mV** **100mV/DIV** **s TIME ns** **20ms/DIV**
 v
- 6 **TRIGGER** **DELAY**
 SOFTKEY 4
 ▲
 ▼
 Use ↕ for
 DELAY:
 ↕select:
 TIME DELAY
 Mode (use A)
 •N-CYCLE
 •EVENTS
 ENTER:
 SOFTKEY 5
- 7 **▼** **↕DELAY**
 -3
- 8 Start the engine.

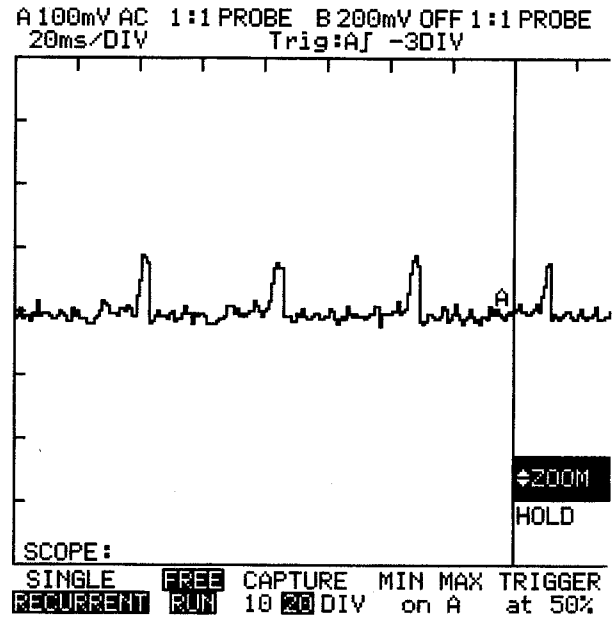

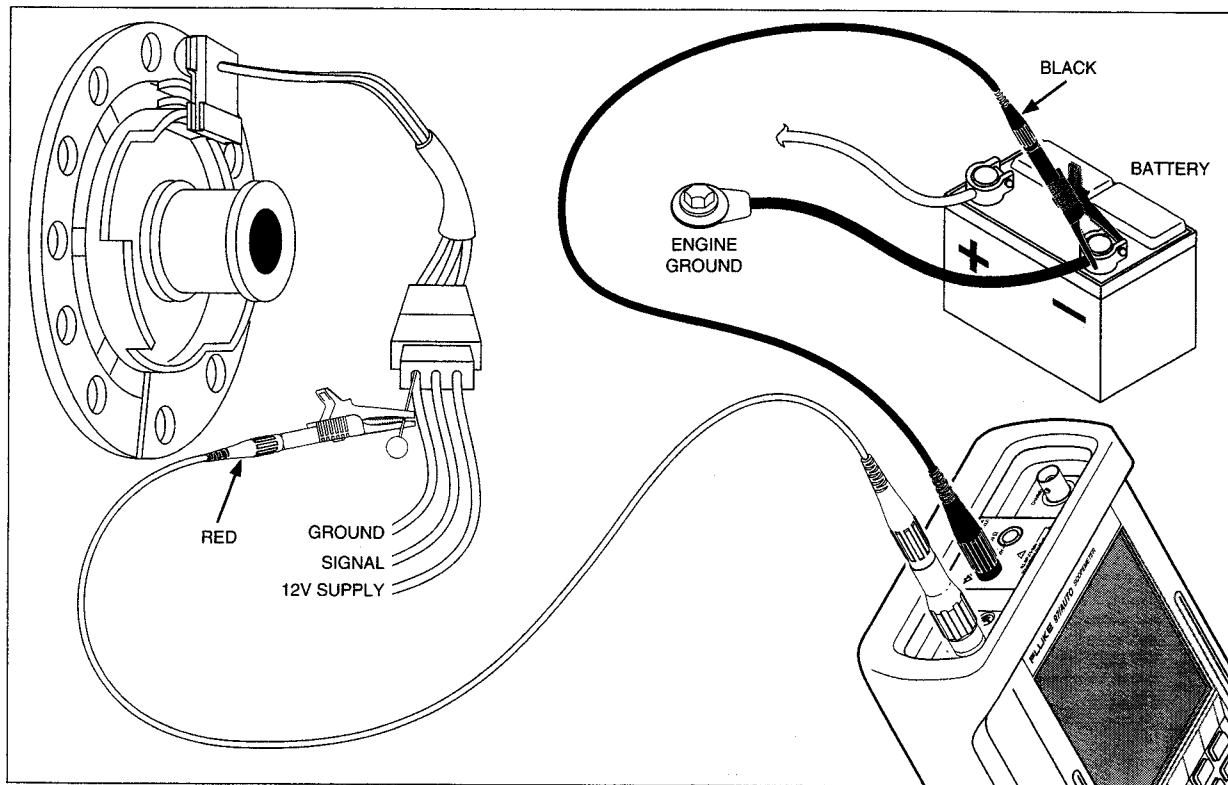

Figure 5-15. RFI/EMI Testing



OXYGEN SENSOR <==> FUEL INJECTOR OR MC SOLENOID

Compare the oxygen sensor voltage level on Channel A to the injector pulse width on Channel B. Voltage level and pulse width are inversely proportional: a higher oxygen sensor voltage means a narrower injector pulse width.

If you are comparing a Mixture Control (MC) Solenoid with an oxygen sensor, the oxygen sensor voltage level and solenoid duty cycle are directly proportional: a higher oxygen sensor voltage means a higher solenoid duty cycle.

The Low Pass Filter Probe and PM9085 Hook Clip used here are available with the K97A Accessory Kit. Contact your tool distributor for more information.

WARNING

TO AVOID ELECTRICAL SHOCK, USE BACK PROBE PINS ONLY IN LOW VOLTAGE CIRCUITS. BACK PROBE PINS MUST NOT BE USED WHERE VOLTAGES GREATER THAN 30V AC OR 60V DC CAN BE ENCOUNTERED.

CAUTION

To avoid fire or damage to electrical circuits, ensure that back probe pins make electrical contact only with the low voltage test point. Do not allow back probe pins to contact any other conductive surface.

97/AUTO Users Manual

① Connect ScopeMeter to the sensor as shown. Use Low Pass Filter Probe for the connection to Channel A.

② **ON OFF**

③ **SCOPE** **SINGLE** **FREE** **CAPTURE**
RECURRENT **RUN** **10 20 DIV**
SOFTKEY 1 **SOFTKEY 2** **SOFTKEY 3**

④ **LCD** **PROBE** **Use ↕ for**
CAL **CAL** **↕** **Cal&ADJUST:**
SOFTKEY 2 **Channel A**
↑ **•1:1**
↓ **•10:1**
•100:1
•1000:1
•AC ADJUST
•DC CAL
Channel B
•1:1
•10:1
•100:1
•1000:1
•AC ADJUST
•DC CAL **ENTER:**
SOFTKEY 5

⑤ **CHAN** **A** **B** **INVERT** **INVERT**
SOFTKEY 1 **SOFTKEY 2**

⑥ **AC DC** **DC** (For both channels A and B.)
GROUND

⑦ **CHANNEL A** **CHANNEL B**
mV **mV**
200mV/DIV **20V/DIV**
v **v**

⑧ **s TIME ns** **5ms/DIV**

⑨ **MOVE** **CHANNEL A and CHANNEL B**
↑ **↓** Move Channel A trace up and Channel B down to the bottom of the display.

⑩ **TRIGGER** **↕DELAY**
SOFTKEY 3 **↑** **↓** **Use ↕ for**
DELAY: **ENTER:**
•select: **SOFTKEY 5**
•TIME DELAY
•Mode (use A)
•N-CYCLE
•EVENTS

⑪ **↕LEVEL**
-3

⑫ **EXT** **+SLOPE** **TRIGGER**
A B **-SLOPE** **LEVEL**
SOFTKEY 1 **SOFTKEY 2** **SOFTKEY 3** **↑** **↕LEVEL**
↓ **+6.40V**

⑬ **HOLD** **NOTRIG**
RUN

⑭ Start engine, run at fast idle for a few minutes to heat the O₂ and check for the display shown. A relationship is apparent between the voltage level on Channel A and the Pulse Width of the injector on Channel B. (When testing a Mixture Control solenoid, the greater the duty cycle, the leaner the mixture.)

An O₂ sensor will output up to 1V in a rich condition and down to 100mV in a lean condition. As the pulse width increases on a fuel injector, more fuel is introduced into the engine.

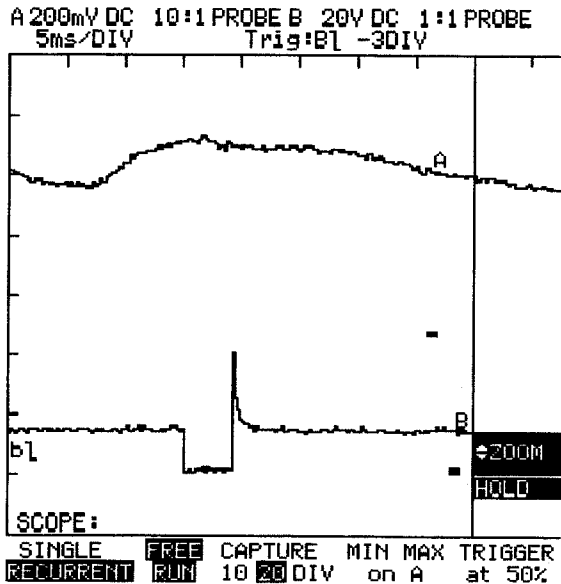

Oxygen Sensor and Fuel Injector Test

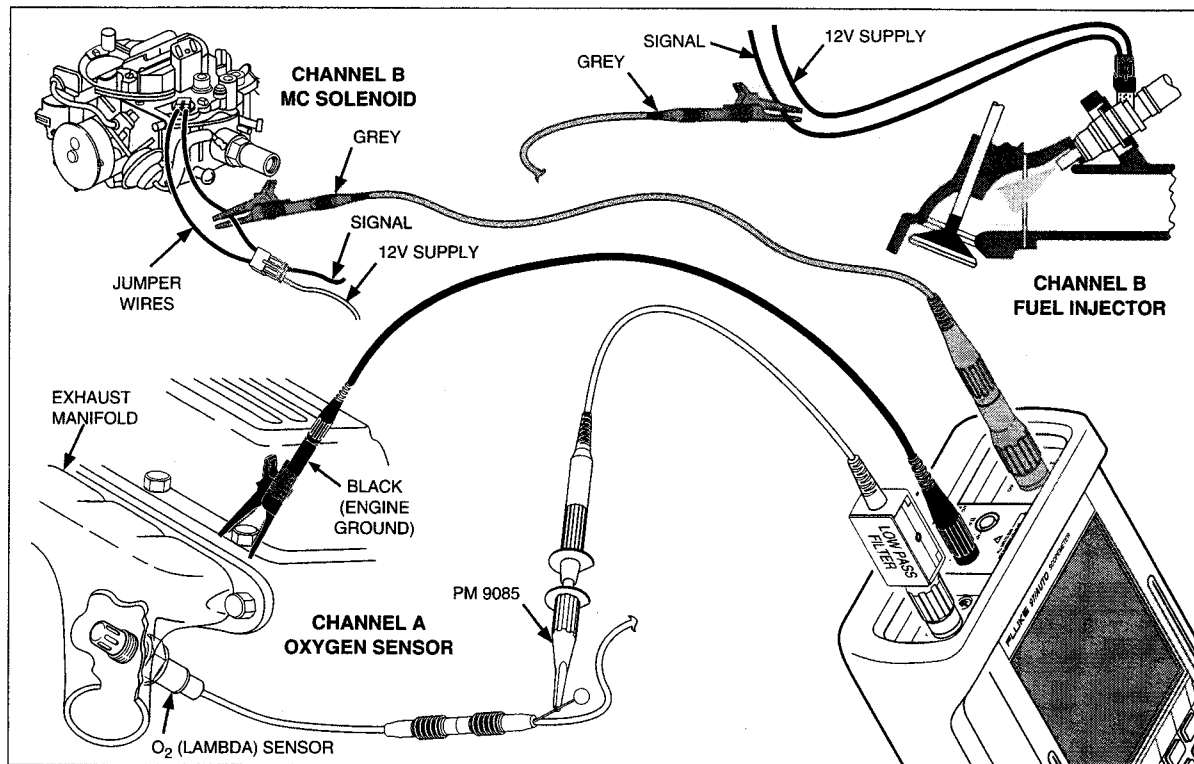

Figure 5-16. Testing Oxygen Sensor and Fuel Injector (MC Solenoid)

Section 6

Advanced Applications

Contents

SECONDARY IGNITION TESTING (CAPACITIVE PICKUP)	6-2	TRANSMISSION PRESSURE COMPARED WITH ECM COMMANDS	6-11
TEMPERATURE MEASUREMENTS	6-5	MANIFOLD ABSOLUTE PRESSURE COMPARED WITH THROTTLE POSITION SENSOR.....	6-15
CURRENT MEASUREMENTS.....	6-8		

CAUTION

Views of ScopeMeter connections in this section are conceptualized only. Refer to manufacturer service information for connection details.

SECONDARY IGNITION TESTING (CAPACITIVE PICKUP)

You can use the Capacitive Pickup to view secondary ignition waveforms with ScopeMeter. The example provided here uses the RPM80 Inductive Pickup as an external triggering device. When spark plug #1 fires, the resulting magnetic pulse is used by the RPM80 to trigger ScopeMeter to display the secondary ignition waveform sensed by the Capacitive Pickup. The displayed waveform can then be diagnosed.

WARNING

THE IGNITION SYSTEM CAN CREATE A POTENTIAL SHOCK HAZARD. ENSURE THAT THE ENGINE IS OFF BEFORE YOU CONNECT OR DISCONNECT THE CAPACITIVE PICKUP AND THE RPM80 INDUCTIVE PICKUP.

The Capacitive Pickup is available with the K97A Accessory Kit. Contact your tool distributor for more information. Refer to the users manual provided with the Capacitive Pickup for complete application setup and usage procedures.

Connect ScopeMeter (Channels A and B) as shown.

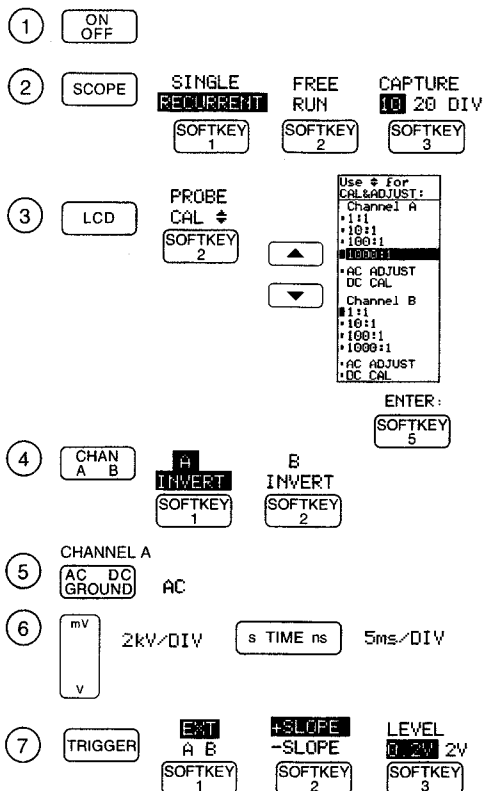



- 8 DELAY
 SOFTKEY 4
 ▲
 ▼
 Use ↕ For
 FUNCTION
 *select:
 *TIME DELAY
 Mode (Use A)
 *N-CYCLE
 *EVENTS
 ENTER:
 SOFTKEY 5
- 9 ▲
 ▼
 DELAY
 -3
- 10 Start engine.
- 11 CURSOR DATA
 FUNCTION
 SOFTKEY 2
 ▲
 ▼
 Use ↕ For
 FUNCTION
 *VOLT at -1-
 *dV
 *dt
 *1/dt
 *TRIG to -1-
 *RMS
 *MEAN
 *PEAK PEAK
 *MAX PEAK
 *MIN PEAK
 *FREQUENCY
 *RISE TIME
 OFF
 ENTER:
 SOFTKEY 5

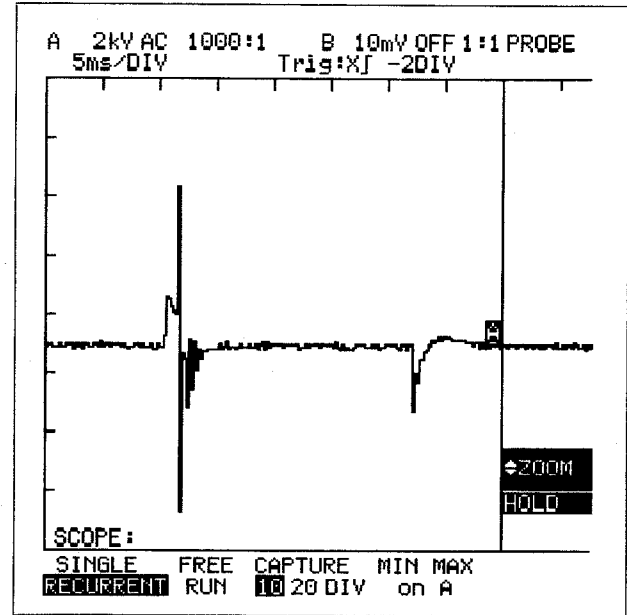

Ignition Test

- 12 <CURSOR>
 -1- >
 <CURSOR>
 -2- >

To position the cursors as necessary.

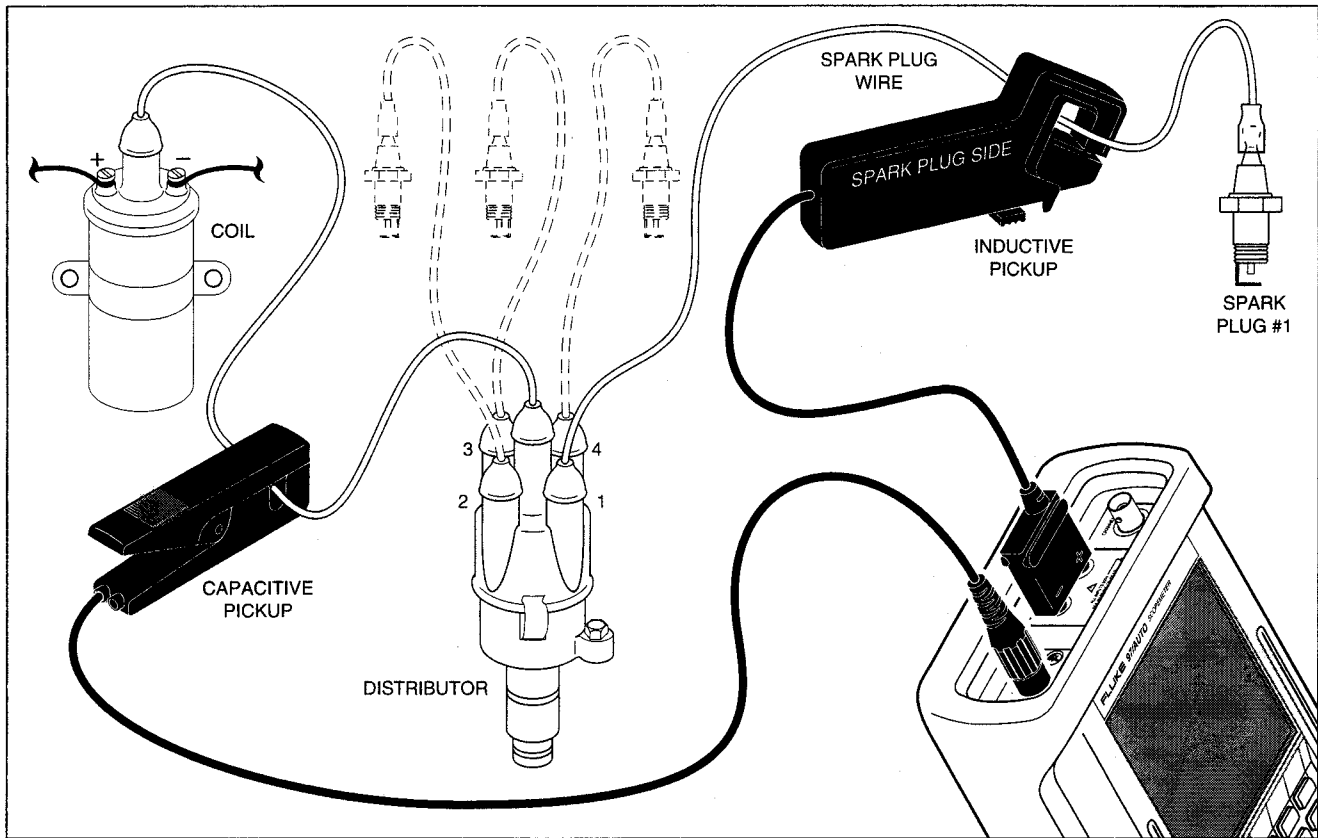

Figure 6-1. Ignition Testing with the Capacitive Pickup



TEMPERATURE MEASUREMENTS

The 80T-150U optional accessory can be used in conjunction with ScopeMeter to measure the surface temperature near a temperature sensor. Readings in millivolts on ScopeMeter are directly proportional to readings in the temperature unit selected on the 80T-150U. For example, 190 mV would equal 190 degrees (Fahrenheit or Celsius, as selected.) Refer to the instruction sheet provided with the 80T-150U for complete information.

In this example, a Coolant Temperature Sensor (CTS) is measured. (If the 80T-150U connection to ScopeMeter is reversed so that the 80T-150U switches face forward, readings will be in negative volts. For example, -190 mV would equal 190 degrees.)

CAUTION

Do not use the 80T150U to measure temperatures in excess of 150° (302°F). Never use the 80T-150U to measure exhaust system temperature. Damage to the temperature probe could otherwise result.

- ① Plug the 80T-150U into the COM and MV (RED) jacks. Be sure that the ON/OFF switch on the 80T-150U is in the OFF position.

A reading of more than 65 mV indicates that the battery is good.

Move the ON/OFF switch to either the °F or °C position.

- ② Prepare ScopeMeter by pressing the following keys:

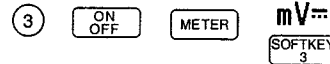

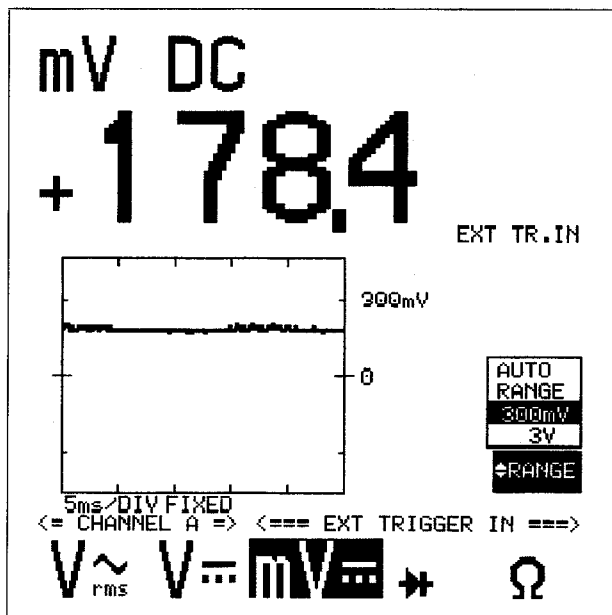

Temperature Measurement

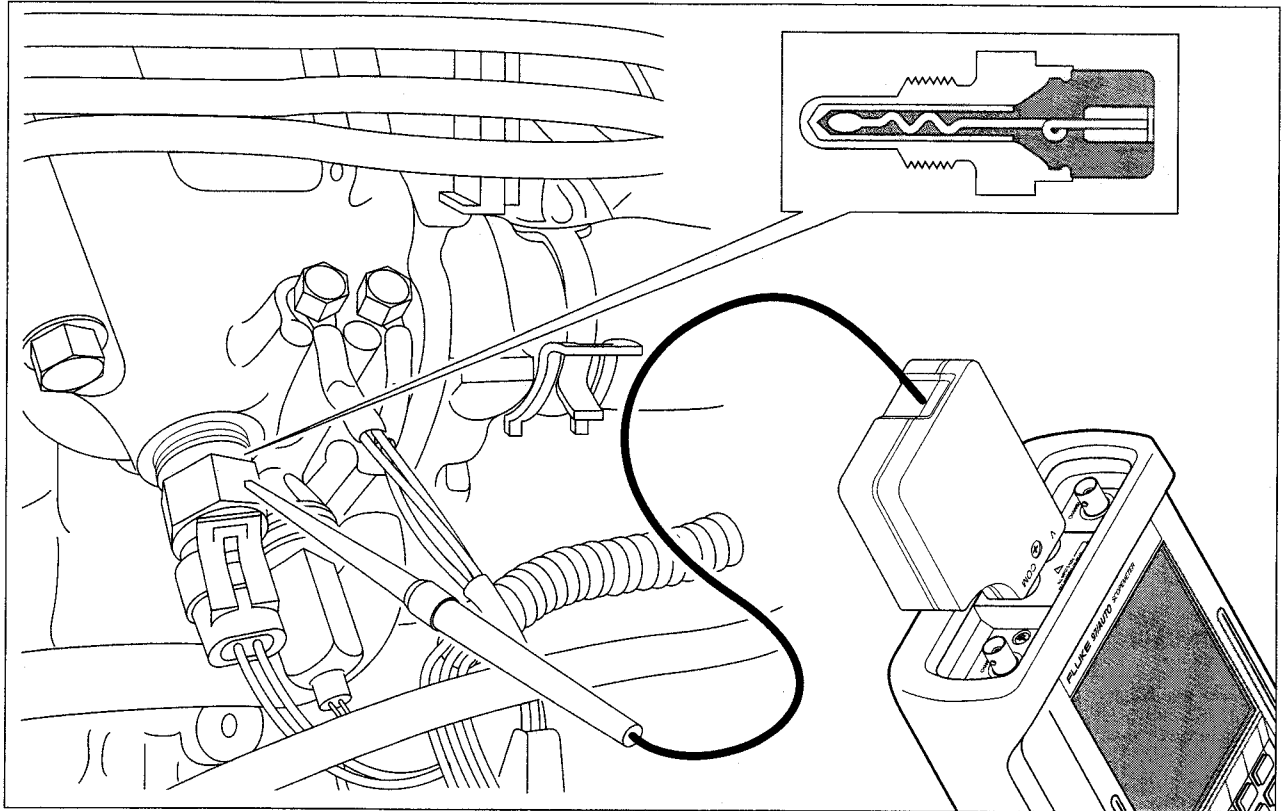

Figure 6-2. Temperature Measurements

CURRENT MEASUREMENTS

The 80i-1010 DC/AC Current Probe is an optional accessory that can be used with ScopeMeter to measure current flow in automotive circuits. Readings in millivolts on ScopeMeter are directly proportional to readings in amps on the 80i-1010. For example, 225 mV would equal 225A. In this example, cranking amps are measured. Refer to the instruction sheet provided with the 80i-1010 for complete information.

- 1 Plug the 80i-1010 into the Ground and MV (RED) jacks.

- 2 Calibrate the 80i-1010 as follows:

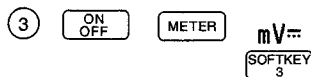

Be sure the ON/OFF switch on the 80T-150U is in the OFF position. A reading of more than 100 mV indicates the battery is good.

- 4 Move the ON/OFF switch to the ON position.
- 5 Rotate the ZERO wheel to display ZEROs on the meter display.
- 6 Prepare ScopeMeter by pressing the following keys:

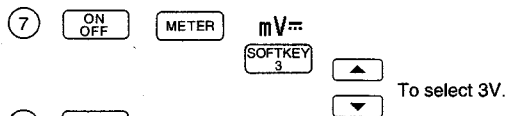

- 8 RECORD
- 9 Clamp the 80i-1010 around all of the wires leading to the negative side of the battery. (With the arrow on the current clamp facing the battery.)
- 10 Crank the engine.
- 11 The results in the MIN display show the current draw of the starter.

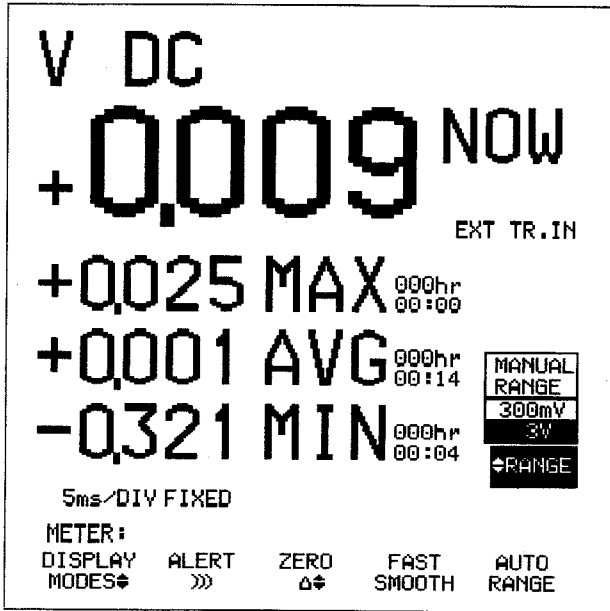

Current Measurement

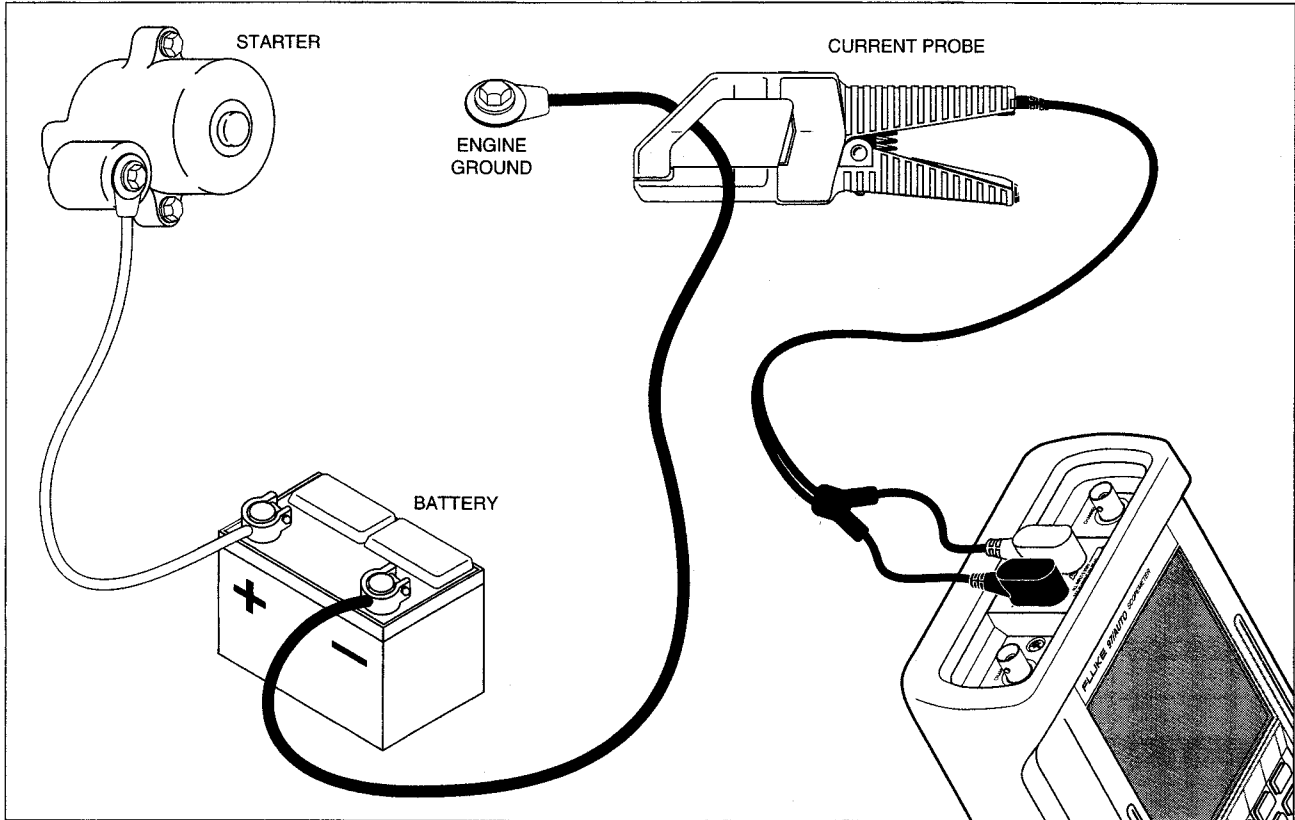

Figure 6-3. Current Measurements



TRANSMISSION PRESSURE COMPARED WITH ECM COMMANDS

You can use the PV500 optional accessory to make direct pressure or vacuum measurements with ScopeMeter. Readings in millivolts on ScopeMeter are directly proportional to readings in the pressure unit selected on the PV500. For example, 25 mV would equal 25 PSI. Vacuum is read as negative millivolts.

WARNING

TO AVOID ELECTRICAL SHOCK, USE BACK PROBE PINS ONLY IN LOW VOLTAGE CIRCUITS. BACK PROBE PINS MUST NOT BE USED WHERE VOLTAGES GREATER THAN 30V AC OR 60V DC CAN BE ENCOUNTERED.

CAUTION

To avoid fire or damage to electrical circuits, ensure that back probe pins make electrical contact only with the low voltage test point. Do not allow back probe pins to contact any other conductive surface.

- 1 Calibrate the PV500 as follows:
Plug the PV500 into the COM and MV (RED) jacks.

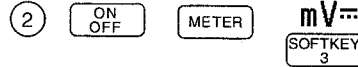

- 3 With the PV500 switch set to OFF, a ScopeMeter display of 88 mV or greater indicates that the PV500 battery is good.

Move the manual switch on the PV500 to the "cmHg inHg" position. Ensure that the METRIC/ENGLISH button is in ENGLISH position. Rotate the ZERO wheel to display ZEROs on the meter display.

- 4 Using the PM9082 Banana Jack to BNC Adapter, connect the PV500 to Channel B.
- 5 Prepare ScopeMeter by pressing the following keys:

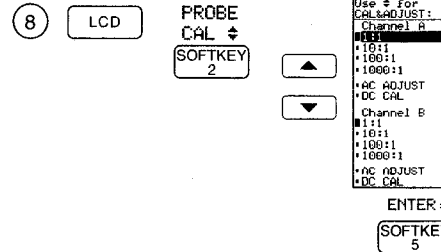
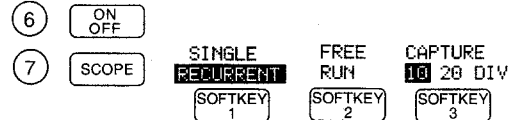

97/AUTO

Users Manual

9 (Channels A and B.)

AC DC
GROUND DC

10

CHANNEL A

CHANNEL B

mV
v

5V/DIV

mV
v

100mV/DIV

11

s TIME ns

100ms/DIV

12

MOVE
▲
▼

(Channel A and Channel B)

Move Channel A trace up and Channel B down to the bottom of the display.

13

TRIGGER

DELAY

SOFKEY 4

▲

▼

Use for
DELAY:
Select:
TIME DELAY
Mode (use A)
N-CVCLE
EVENTS

ENTER:

SOFKEY 5

14

▲

▼

LEVEL

-2

15

TRIGGER
LEVEL

SOFKEY 3

▲

▼

LEVEL

+2.00V

16

+SLOPE

-SLOPE

SOFKEY 2

17

EXT

A B

SOFKEY 1

18

Drive the vehicle with the ScopeMeter connected to the transmission to obtain a display. Use the cursors to compare delay of the rise times from signal command to pressure change.

19

When analyzing the results with the cursors ON, excessive DELTA TIME or BASE TIME may indicate the need to increase or decrease orifice sizes in the transmission.

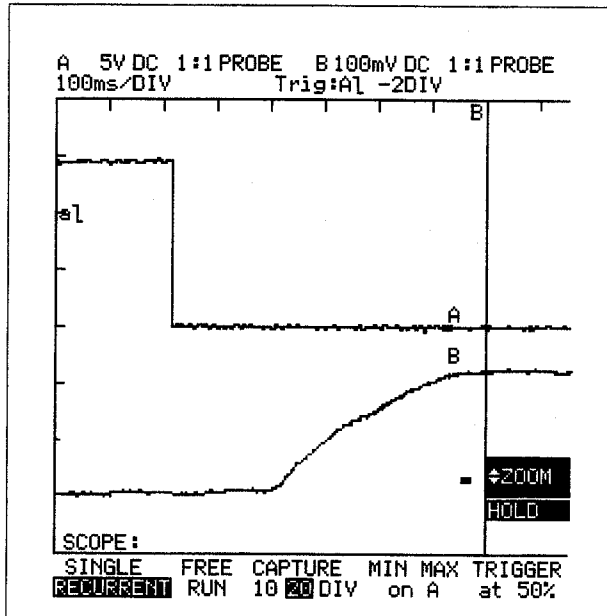

Transmission Pressure and ECM Command Test

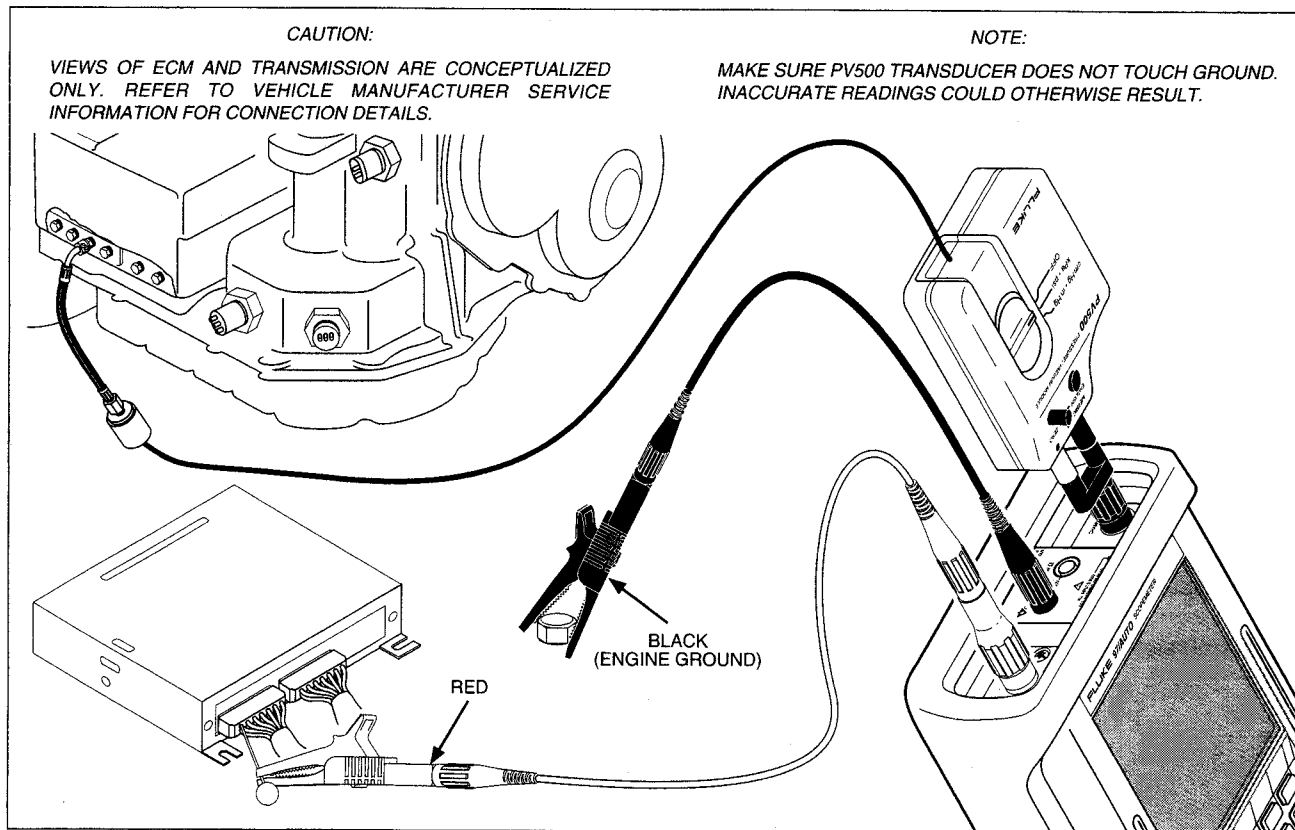

Figure 6-4. Testing Transmission Pressure and ECM Commands



MANIFOLD ABSOLUTE PRESSURE COMPARED WITH THROTTLE POSITION SENSOR

Begin with the engine off. In the following steps, you will calibrate the PV500 to the ambient atmospheric pressure, then compare the Throttle Position Sensor signal to the MAP signal.

WARNING

TO AVOID ELECTRICAL SHOCK, USE BACK PROBE PINS ONLY IN LOW VOLTAGE CIRCUITS. BACK PROBE PINS MUST NOT BE USED WHERE VOLTAGES GREATER THAN 30V AC OR 60V DC CAN BE ENCOUNTERED.

CAUTION

To avoid fire or damage to electrical circuits, ensure that back probe pins make electrical contact only with the low voltage test point. Do not allow back probe pins to contact any other conductive surface.

- ① Plug the PV500 into the COMand MV(RE)D jacks.
- ② Calibrate the PV500 as follows:

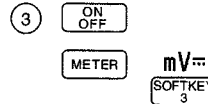

With the PV500 switch set to OFF, a ScopeMeter display of 88 mV or greater indicates that the PV500 battery is good.

Move the manual switch on the PV500 to the cmHg * inHg position. Ensure that the METRIC/ENGLISH switch is in ENGLISH position. Rotate the ZERO wheel to display ZEROs on the meter display.

- ④ Using the PM9082 Banana Jack to BNC Adapter, connect the PV500 to Channel B.
- ⑤ Prepare ScopeMeter by pressing the following keys:

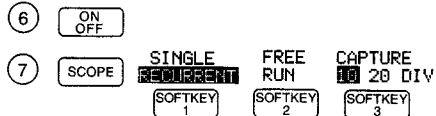

97/AUTO

Users Manual

8 LCD PROBE CAL \updownarrow SOFTKEY 2

Channel A
 1:1
 *10:1
 *100:1
 *1000:1
 *AC ADJUST
 *DC CAL

Channel B
 1:1
 *10:1
 *100:1
 *1000:1
 *AC ADJUST
 *DC CAL

ENTER:
 SOFTKEY 5

9 Channels A and B.
 AC DC GROUND DC

10 CHANNEL A CHANNEL B

mV 1V/DIV v

mV 10mV/DIV v

11 s TIME ns 100ms/DIV

12 CHANNEL A and CHANNEL B. Move Channel A trace up and Channel B down to the bottom of the display.

MOVE \updownarrow

13 TRIGGER \updownarrow DELAY SOFTKEY 4

Use \updownarrow For DELAY:
 \updownarrow select:
 TIME DELAY
 Mode (Use A)
 *N-CYCLE
 *EVENTS

ENTER:
 SOFTKEY 5

14 \downarrow \updownarrow LEVEL -3

15 TRIGGER LEVEL SOFTKEY 3

\updownarrow \updownarrow LEVEL +1.00W

\updownarrow SLOPE -SLOPE SOFTKEY 2

16 Start the engine and sweep the throttle to obtain a display. Compare the results to the waveforms shown. Use the cursors to compare delay between the rise times.

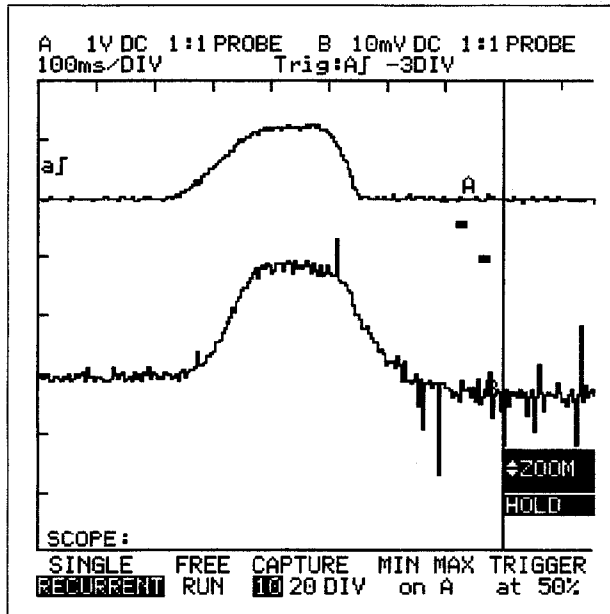

TPS and Manifold Pressure Test

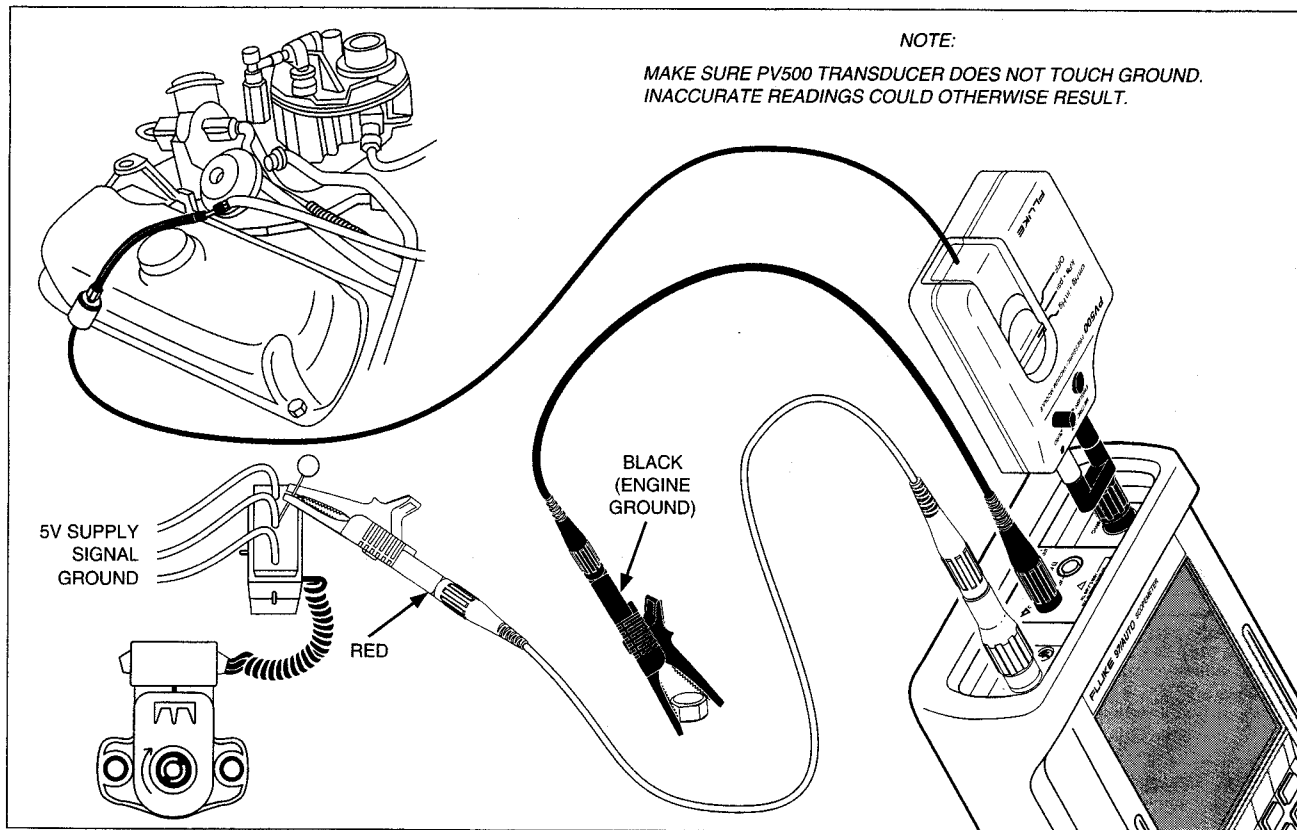

Figure 6-5. Testing TPS and Manifold Absolute Pressure

Section 7

User Maintenance

Contents

GENERAL MAINTENANCE	7-2	USING 10:1 PROBES	7-7
Cleaning	7-2	Probe Selection	7-7
REPLACING THE BATTERIES	7-2	Probe Calibration	7-7
FUSE REPLACEMENT	7-4	PRESETTINGS	7-7
PERFORMANCE TEST	7-4	DC CALIBRATION	7-8
Preparation (Scope and Meter)	7-4	AC ADJUSTMENT	7-8
Scope Verification	7-6	IF YOUR SCOPEMETER DOES NOT WORK	7-9
Meter Verification	7-6		

GENERAL MAINTENANCE

Cleaning

Clean ScopeMeter with a damp cloth and a mild detergent. Do not use abrasives, solvents, or alcohol.

REPLACING THE BATTERIES



WARNING

TO AVOID ELECTRICAL SHOCK, REMOVE THE TEST LEADS, PROBES, AND BATTERY CHARGER BEFORE REPLACING THE BATTERIES.



WARNING

WHEN SCOPEMETER IS CONNECTED TO ITS POWER ADAPTER/BATTERY CHARGER, TERMINALS MAY BE LIVE, AND THE OPENING OF COVERS OR REMOVAL OF PARTS (EXCEPT THOSE THAT CAN BE ACCESSED BY HAND) IS LIKELY TO EXPOSE LIVE PARTS.

SCOPEMETER MUST BE DISCONNECTED FROM ALL VOLTAGE SOURCES BEFORE IT IS OPENED FOR ANY ADJUSTMENT, REPLACEMENT, MAINTENANCE, OR REPAIR.

USE ONLY INSULATED PROBES, TEST LEADS, AND CONNECTORS SPECIFIED IN THIS MANUAL WHEN MAKING MEASUREMENTS >42V PEAK (30V RMS) ABOVE EARTH GROUND OR ON CIRCUITS >4800 VA. USE PROBES AND TEST LEADS WITHIN RATINGS AND INSPECT BEFORE USE.

CAPACITORS INSIDE SCOPEMETER MAY STILL BE CHARGED EVEN IF SCOPEMETER HAS BEEN DISCONNECTED FROM ALL VOLTAGE SOURCES.

1. Disconnect the test leads, probes, and battery charger both at the source and at ScopeMeter.
2. Separate ScopeMeter from its holster.
3. Locate the battery cover on the bottom rear of ScopeMeter. Loosen the two screws with a flat-blade screwdriver.
4. Lift the battery cover away from ScopeMeter.

NOTE

At this point, be sure that you have new batteries ready for installation into ScopeMeter. When the batteries are removed, ScopeMeter retains memory for approximately 30 seconds.



If the batteries are not replaced within this time limit, ScopeMeter loses setup and waveform memory, returning to the Master Reset configuration.

5. Lift the NiCad battery pack (or loose alkaline batteries, type KR27/50 or R14) out of the battery compartment.



NOTE

This instrument contains a Nickel-Cadmium battery. Do not dispose of this battery with other solid waste. Used batteries should be disposed of by a qualified recycler or hazardous materials handler. Contact your authorized Fluke Service Center for recycling information.

6. Install a new NiCad battery pack (PM9086/001) or new alkaline batteries (type KR27/50 or R14) as shown in Figure 7-1.

NOTE

Ensure that the NiCad battery pack charging contact is aligned in the battery compartment as shown in Figure 7-1. Use only the PM9086/001 NiCad battery pack.

7. Reinstall the battery cover and secure the two screws.

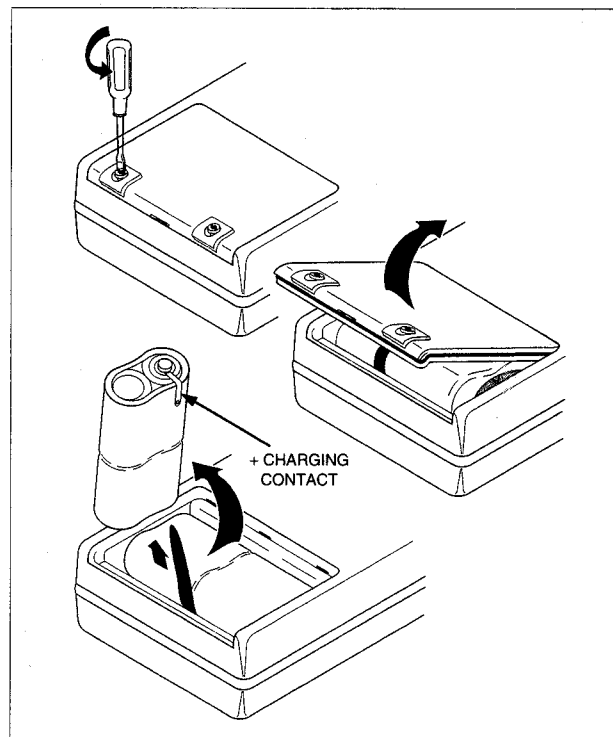

Figure 7-1. Battery Replacement

FUSE REPLACEMENT

Since ScopeMeter uses electronically protected inputs, no fuses are required.

PERFORMANCE TEST

This procedure uses a minimum of test steps and actions to verify basic ScopeMeter operation and measurement accuracy.



NOTE

The procedure does not check all ScopeMeter specifications; refer to the Service Manual (P/N 915970) for a complete ScopeMeter Performance Verification Procedure.

The ScopeMeter's internally-generated 1.95-kHz, 5V p-p square wave signal can be measured as a performance verification procedure. This signal can be measured in both the Scope and Meter modes.

Preparation (Scope and Meter)

Complete the following setup steps:

1. With power OFF, press and hold , then press and release .
2. Make the following connections (see Figure 7-2):
 - Red BNC adapter to CHANNEL A BNC input.
 - Red test lead from red BNC adapter to GENERATOR OUT red banana jack.

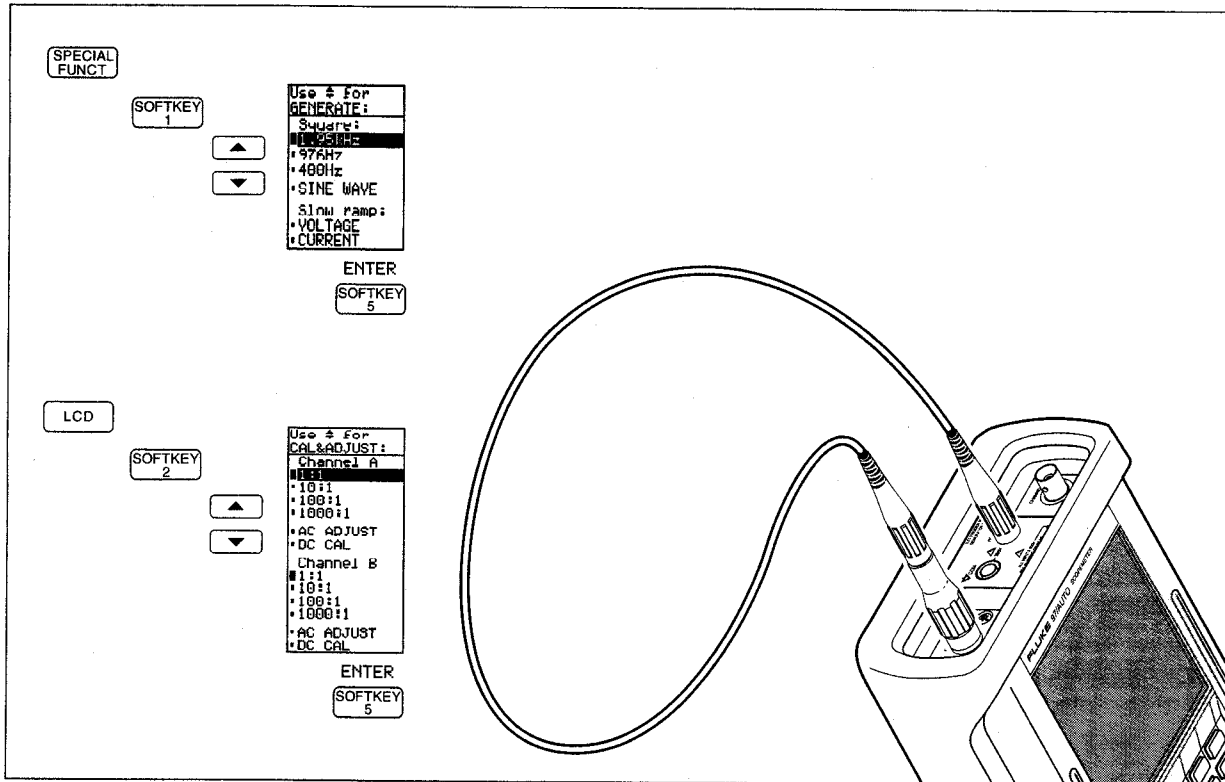

Figure 7-2. Performance Test Setup

- Press **SPECIAL FUNCT** **SOFTKEY 1** to verify that the internal signal generator is on. If a large square appears to the left of 1.95kHz, the generator is already on; press **SPECIAL FUNCT** to exit this menu without making a change. If a small dot appears next to 1.95kHz, press **▲** or **▼** to highlight 1.95kHz. Then press **SOFTKEY 5** (ENTER) to activate this selection.
- Press **AUTO SET**.

Scope Verification

Use the following procedure to verify scope operation:

- Perform all steps in the Preparation section if not done previously. Then press **SCOPE**.
- Press **AC DC GROUND** for dc channel input coupling on Channel A. Look for DC in the upper left corner of the display.
- Press **V** or **mV** for Channel A to select the amplitude per vertical division. Select A 1V DC, as shown in the upper left corner of the display.
- Press **s TIME ns** to select a time base of 200 μ s/DIV (flashes momentarily in the upper left corner of the display.)
- Press **CURSOR DATA**, then press **SOFTKEY 2** (FUNCTION). Press **▼** **▲** (followed by **SOFTKEY 5**) to select PEAK/PEAK and FREQUENCY. Then press **SOFTKEY 2** (FUNCTION).

ScopeMeter now displays the internal generator output of 1.95 kHz \pm 1% at 5V p-p \pm 10%.

To verify the scope operation of channel B, proceed in the same order as for Channel A; however, use the GREY channel B BNC socket and the GREY test lead.

Meter Verification

Use the following procedure to verify meter operation:

- Perform all steps in the Preparation section if not done previously.
- Press **METER**. ScopeMeter sets itself to the Meter Mode.

NOTE

Meter operation is verified on channel A only. Channel B cannot be used in Meter Mode.







- Press **SOFTKEY 1** Vrms AC. Look for a display of 2.500 \pm 10%, with the 3V range selected in the Right Menu.
- To end the operation verification procedure, press **SPECIAL FUNCT**. Press **SOFTKEY 1** (GENERATE), then **▼** **▲** to highlight 1.95kHz, if needed. Press **SOFTKEY 5** (ENTER) to turn off the generator. Press **ON OFF** to turn off ScopeMeter.

**NOTE**

If you cannot achieve the desired results in Scope and/or Meter Mode, perform a Master Reset. Then repeat the entire Performance Test. Remember that a Master Reset erases all waveform and setup memory.

USING 10:1 PROBES**Probe Selection**

This manual assumes use of the 1:1 Flexible Test Leads in all descriptions and examples. To select the 10:1 Test Probes, use the following procedure:

1. Access the Probe Cal Pop-Up Menu. Press  .
2. Press   to highlight 10:1 for channel A. Press  to activate this selection.
3. Now press  again, highlight 10:1 for channel B, and press .

NOTE

Performing a Master Reset provides you with a shortcut: 10:1 is set for both channels. But remember, all setup and waveform memory will be lost and only master reset default settings will be assumed.



Probe Calibration

The following procedures describe dc calibration and ac adjustment for the 10:1 accessory probe used on CHANNEL A (RED scope probe) and CHANNEL B (GREY scope probe).

NOTE

To meet full user specifications, use scope 10:1 probes only with the inputs on which they have been calibrated.



PRESETTINGS

1. Press  ON.
2. Connect the red scope probe to the CHANNEL A (red) BNC input.
3. Connect the red adjust adapter to the GENERATOR OUT red banana jack.
4. Connect the red scope probe to the red adjust adapter.
5. Press .
6. Press  (PROBE CAL) to select the Probe Calibration Pop-Up Menu.

NOTE

You must select "10:1" in the Probe Cal Pop-Up Menu before performing DC or AC Calibration for the 10:1 probe.

DC CALIBRATION





1. Perform the steps given above under “Presettings.”
2. Press  or  to select DC CAL for Channel A.
3. Press  to select DC CAL. The gain of the probe is calibrated automatically.

ScopeMeter outputs a voltage on the GENERATOR OUT banana jack to the connected probe. If a 1:1 or 10:1 probe has been connected, ScopeMeter automatically calibrates itself to the probe.

PROBE successfully calibrated is displayed when DC CAL is completed. ScopeMeter then returns to its previous setup.

4. Repeat these steps for Channel B.

AC ADJUSTMENT

1. Perform the steps given previously under “Presettings.”
2. Press  or  to highlight 10:1. Then press  (ENTER) to make the selection.
3. Press  (PROBE CAL) again. Then highlight AC ADJUST and press . ScopeMeter now sets itself automatically to the correct attenuation and time base and begins outputting a square wave from the GENERATOR OUTPUT banana jack to the connected probe.
4. The probe can now be adjusted. Adjust the trimmer screw in the probe housing of channel A to give an optimum square wave within the markers on the display.

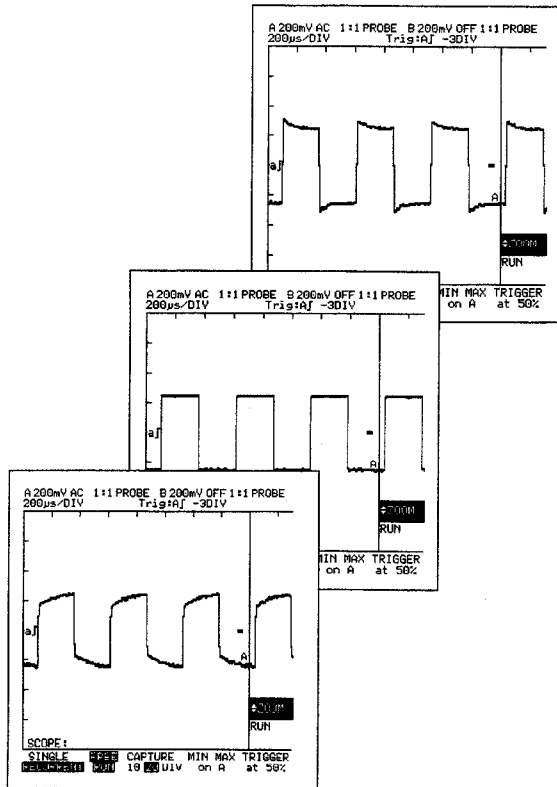

Adjusting the Probe (10:1)

5. Press to exit AC ADJUST.
6. Repeat these steps for Channel B.







NOTE

Unless otherwise directed, do not use 97/AUTO ScopeMeter with 100:1 or 1000:1 probes.

IF YOUR SCOPEMETER DOES NOT WORK

If you are having trouble making a reading or displaying a waveform, make the following checks:

1. Try a shortcut first: press .
2. Check input connections. Try connecting ScopeMeter to a known good signal: connect ScopeMeter's GENERATOR OUT to CHANNEL A. Verify that the generator is on (press and check that a box appears to left of and check that a box appears to left of 1.95kHz, 976Hz, 400Hz, or SINE WAVE. Press again.
3. In Meter Mode, check the following settings:
 - FUNCTION. Are you making the type of measurement you want?
 - RANGE. Does the range yield a meaningful display?

- **DISPLAY MODES.** Are the intended measurement conversions shown?
 - **COUPLING.** Press  for Channel A a few times.
4. In Scope Mode, check the following areas:
- **CHANNEL SELECTION.** If OFF appears by the channel in the upper row of the top display, press  and turn the channel on.
 - **VOLTAGE SCALE.** Press   for the channel to select an appropriate scale.
 - **TIME BASE.** Press  to select a meaningful time base.
 - **TRIGGER:** Check that RECURRENT and FREE RUN are on and that a trigger source is selected. If HOLD is flashing, press .
 - **COUPLING:** If necessary, press  for the input channel to select DC as seen in the upper row of the top display.
- If you continue to have a problem with ScopeMeter, contact your vendor.

Section 8 Appendices

Contents

8A. Specifications	8-3
8B. Parts and Accessories.....	8-13
8C. Warranty and Service Centers	8-19
8D. Terminology	8-25
8E. Menu Trees	8-33
8F. Duty Cycle to Dwell Conversion.....	8-39

Appendix 8A

Specifications

INTRODUCTION

Performance Characteristics

FLUKE guarantees the properties expressed in numerical values with the stated tolerance. Specified non-tolerance numerical values indicate those that could be nominally expected from the mean of a range of identical ScopeMeters.

For definitions of terms, refer to IEC Publication 351-1.

Safety Characteristics

ScopeMeter has been designed and tested in accordance with IEC Publication 348, Safety Requirements for Electronic Measuring Apparatus. This manual contains information and warnings that must be followed by the user to ensure safe operation and to keep ScopeMeter in a safe condition. Use of this equipment in a manner not specified by the manufacturer may impair protection provided by the equipment.

Environmental Data

The environmental data mentioned in this manual are based on the results of the manufacturer's verification procedures.

MULTIMETER

DC Volt

Ranges: 300 mV, 3V, 30V and 300V
Accuracy: $\pm 0.5\%$ ± 5 counts

AC Volt

Ranges: 300 mV, 3V, 30V and 250V
Accuracy:

$\pm 1\%$ ± 10 counts, 50 Hz to 60 Hz
 $\pm 2\%$ ± 15 counts, 20 Hz to 20 kHz
 $\pm 3\%$ ± 20 counts, 5 Hz to 1 MHz
Additional error $\pm 1\%$ ± 1 kHz

For < 10 Hz with 10:1 probe or < 100 Hz direct (1:1 probe), use function V_{rms} AC + V DC.

The 10:1 accessory probe increases the ranges by a factor of 10.

To create more accurate measurements on ac, or on dc with a large ac component, the time base often can be optimized by pressing **AUTO SET** or by changing the setting accessed by pressing **s TIME ns**.

mV DC

Ranges: 300 mV and 3V
Accuracy: $\pm 0.5\%$ ± 5 counts

This range has a low-pass filter with a bandwidth of 5 kHz.

Ω

Ranges: 300 Ω , 3 k Ω , 30 k Ω , 300 k Ω , 3 M Ω and 30 M Ω .
Accuracy: $\pm 0.5\%$ ± 5 counts
Range: 30 Ω
Accuracy: $\pm 2.5\%$ ± 25 counts

Diode

Measuring Current: 0.5 mA
Maximum Voltage: 4V

If Output Voltage is higher than 2.8V, OL (OverLoad) is displayed.



Display Modes

FREQUENCY

The frequency can be displayed within the following parameters:

Range: 1 Hz ... 5 MHz

Accuracy: $\pm 0.5\%$

Resolution: 4 digits

TRACE DISP

The display trace can be switched off.

DUTY%+, DUTY%-

Relative on-to-off time of a varying input can be displayed as a percentage.

- Range: from $<2.0\%$ to $>98.0\%$ for signal amplitudes $>10\%$ of the input voltage range.
- Resolution: 0.1%
- Accuracy (logic or pulse waveforms): within $\pm 0.5\%$
- Accuracy (sine or triangle waveforms): within $\pm 1\% + ((\text{Voltage Range}/\text{RMS Input Voltage}) \times 1\%)$

%/DELTA

Displays the difference after $\text{0}\%$ or $\text{\%}\Delta$ is pressed.

SCALING

0% and 100% can be set, creating an $a + bx$ computed reading where a and b are the 0 and 100% values, respectively, and x is the measured value.

VOLT MATH

Results can be displayed in dBV, dBm, dBW, or Audio Watt. The assumed load resistance can be chosen from: 1, 2, 4, 8, 16, 50, 60, 75, 93, 110, 125, 135, 150, 200, 250, 300, 500, 600, 800, 900, 1000 or 1200Ω , depending on the display mode.

Record

In Meter Mode, the actual value is displayed simultaneously with the maximum, average, and minimum values.

Touch Hold® Feature

Can be activated by pressing .

OSCILLOSCOPE**Vertical System****DEFLECTION FACTOR**

1 mV to 100V per division in 1-2-5 sequence, for time base 60s/division to 1ms/division. This can be expanded by a factor of 10 with the 10:1 accessory probe.

VERTICAL RESOLUTION

8 bits, 25 levels per division.

DC ACCURACY

$\pm 2\%$

RISE TIME

Vertical amplifier response limits the rise time to 7 ns. For time base settings slower than 200 ns the rise time is smaller than the sample distance, so the measured rise time is unreliable if it is smaller than $(2 \times s/div)/25$

BANDWIDTH

With 10:1 probe only: > 50 MHz (-3 dB)

NONLINEARITY

Including Analog to Digital Converter, which will have no missing codes and is monotonic: $\pm(2\% \pm 1 \text{ digit})$

MOVE CONTROL RANGE

From +4 divisions to -4 divisions

DC BALANCE

Base line is automatically readjusted after switching the attenuator or ac/dc/ground.

MIN/MAX

Acquisition mode at 1 ms per division or slower on Channel A only. Pulse width for 100% probability of detection is 40 ns.

AVERAGE

The running average can be set to 256 maximum. In Roll Mode, the average is fixed at 10.

ZOOM

Expand or contract view centered around the 4th division, within the limits of the time base and the maximum delay.

Horizontal System**RANGE**

5s to 10 ns per division with triggered start.

The Roll Mode is active from 60s to 10s.

Single shots are possible from 5s to 100 ns per division.



For time base settings faster than 1 ms, an automatic interpolation takes place. The useful bandwidth is about 6 MHz.

For time base settings of 50 ms or slower, the channels are chopped.

For time base settings of 20 ms or faster, the channels are alternated. Channel A is displayed first and, after a second trigger pulse, Channel B is displayed second.

ACCURACY

Accuracy is $\pm 0.1\% \pm 1$ LSB

SAMPLE FREQUENCY

Dependent on time base:

(25/sec-per-div) Hz (maximum 25 MHz)

In Min/Max: 25 MHz

RECORD LENGTH

512 samples calibrated for 25 samples per division.

CAPTURE allows selection of a record length of 10 or 20 divisions.

MOVE CONTROL

From +4 divisions to -16.5 divisions.

A VERSUS B

Channel A is displayed along the vertical axis, and Channel B along the horizontal axis. The time base is set manually.

Trigger

INTERNAL SENSITIVITY

For frequencies lower than 10 MHz: <0.8 div

Extra amplification in the vertical system allows for 2 mV and 1 mV per division for the input signal, but not for the trigger. Therefore, sensitivity at 2 mV and 1 mV decreases by a factor of 5.

LEVEL RANGE

From +4 divisions to -4 divisions.

EXTERNAL

TTL compatible. Selectable for 0.2V or 2V.

Trigger level is indicated on the screen.

DELAY RANGE

TIME DELAY: -20 to +640 divisions

EVENTS: 1 to 1023

N_CYCLE: trigger frequency divided by N (2 to 255.)

Waveform Memories

For waveform storage, eight extra memories are available. The memories can be cleared all together.

Each memory contains 512 words for waveform and the setup belonging to this waveform.

Mathematics

The following math functions can be carried out on the waveforms: multiplication, addition, subtraction, filtering, inversion, and integration. The result is stored in a selected memory.

Cursors

The following measurements can be made on the waveform selected between the cursors:

- dV, dt, 1/dt, RMS, mean, maximum, minimum, peak to peak, rise or fall time, frequency, and phase.
- The time between trigger and cursor.
- Ratio
- The voltage at the cursor relative to ground.

A maximum of any five of these measurements can be displayed at the right hand side of the display.

Autoset

Autoset automatically sets the vertical deflection, the horizontal time base, and the trigger selection. Trigger selection can be left unaffected by selecting ONLY AMPLITUDE, ONLY TIME, or TIME & AMPLITUDE.

Autoset can also be fully configured via a Pop-Up Menu. Selections are as follows (default in parentheses):

VERTICAL

MOVE: (zero), or not affected
Input Coupling: (ac), or not affected
A versus B: (off), or not affected
Average: (off), or not affected
Separation, 1 channel: (Center of screen)
Separation, dual channel: (Channel A+1 div, Channel B-1 div)

HORIZONTAL

MOVE: (zero), or not affected

TRIGGERING

Delay (>0): (off), or not affected
Delay (<0): (not affected)
Include External: include external or (A or B)
Level: (50% of signal), or not affected
Slope: (positive), or not affected

MISCELLANEOUS

Cursors: (not affected), or off
Mathematics: (off), or not affected
Generator: (not affected), or off
Dot Join: (not affected), or off



Record

In Scope Mode, all the measured values are displayed. A reset is possible every 2, 5, 10, or 60 seconds.

GENERATOR

The generator can be used for probe calibration. The output impedance is typically 400Ω.

- Square Wave

Amplitude: 5V p-p typical
Frequency: 488 Hz, 976 Hz or 1.95 kHz (selectable)

- Sinewave

Amplitude: 1V p-p typical
Frequency: 976 Hz

- Slow Ramp Current

Range: 0 to 3 mA
Maximum Voltage: 2V

- Slow Ramp Voltage

Range: -2V to 2V
Maximum Current: 1 mA

SETUP MEMORIES

A maximum of 10 setups (meter and/or scope) can be stored. You can recall, save, or delete each

setup. Separate Initial Setup and Auto Set memories are also maintained.

UNDO

The front panel setup is stepped backward once per press of . After 10 steps backward, continued presses step the setup forward.

GENERAL

Input Terminals (Channels A, B and External Trigger)

Impedance: 1 MΩ // 25 pF

Maximum Voltage: 300V up to 1 MHz (maximum allowed voltage decreases 6 dB per octave at higher frequencies)

The maximum input voltage between any terminal and earth ground is 600V.

Input Protection: The inputs are protected for line voltages of 600V and surge voltages of 4 kV.

Channels A and B have insulated BNC connectors. Two 4-mm banana jacks are used for external triggering, mV DC measurement, resistor measurement, diode testing, and generator output.

Commons of all inputs are connected together.

Display

LCD Type: Super Twisted Nematic

Active Area: 240x240 pixels, diagonal of 4.7 inches (12 cm).

Trace Area: 200x240 pixels

A graticule with 25 pixels per division can be chosen via softkey.

An electro-luminescent backlight can be activated via softkey.

The CONTRAST ratio is adjustable in the LCD Softkey Menu.

External Power Requirements

Input Voltage Range: 8V to 20V



WARNING

THE MINUS VOLTAGE IS CONNECTED TO COMMON. WHEN USING A POWER SUPPLY THAT IS NOT DOUBLE INSULATED, CONNECT COMMON TO PROTECTIVE GROUNDING.

Power Consumption: 5W (typical)

Internal Battery Power

Operating Time

NiCad Pack: 4 hours (typical)

Alkaline C-Cell: 4 hours (KR27/50 or R-14 size can be used.)

Charging Time: 16 hours (typical) while not operating

Charging Current:

100 mA with ScopeMeter ON

200 mA with ScopeMeter OFF

Maximum Temperature During Charging: 45 °C

Temperature and Humidity

Operating Temperature: 0 °C to 50 °C

Storage Temperature: -20 °C to 70 °C

Relative Humidity:

90% from 20 °C to 30 °C

70% from 30 °C to 50 °C

Shock and Vibration

Per MIL-T-28800 for a Class 3 instrument.

Meets requirements of MIL-T-28800D Type III Class 3, Style C, except for temperature range and power switch.



Size (HxWxL)

ScopeMeter only

60 mm x 129 mm x 262 mm
(2.4 inch x 5.1 inch x 10.3 inch)

With holster

62 mm x 140 mm x 281 mm
(2.5 inch x 5.5 inch x 11.1 inch)

Weight

ScopeMeter only: 1.5 kg (3.3 lbs)

With holster: 1.8 kg (4.0 lbs)

Safety

Designed to protection Class II per IEC 348 and UL1244 for 600V.

Sealing

Dust and splash proof

Appendix 8B

Parts and Accessories

SERVICE MANUAL

Order Part Number 915970.

STANDARD KIT CONTENTS

Table 8B-1. 97/AUTO ScopeMeter Standard Kit (North America)

QTY	DESCRIPTION	MODEL	FLUKE PART NUMBER
1	Yellow Holster	-	935379
1	ScopeMeter Hard Carrying Case	FLUKE 97/A-8007	932736
1	Training Package	Call 1-800-44FLUKE	
1	Inductive Pickup	RPM80	880849
1	NiCad Battery Pack (installed)	PM9086/001	916072
1	Quick Operating Guide	-	916127

Table 8B-1. 97/AUTO ScopeMeter Standard Kit (North America) (cont)

QTY	DESCRIPTION	MODEL	FLUKE PART NUMBER
1	Users Manual	Manual, English, 97A	932835
1	Universal Adapter/Charger	PM8907/008	916080
1	Automotive Power Adapter	PM9087/002	926964
1	Accessory Case (Soft)	C75	865535
1	Adapter, Banana Jack - Male BNC (set of two, red and grey)	PM9095/001	934984
1	Alligator Clips, Large Jaw Red	AC85A - R	927749
1	Black	AC85A - B	927756
1	Grey	AC85A - G	928007
1	Flexible Test Leads Red	-	922083
1	Black	-	922075
1	Grey	-	935382



Table 8B-1. 97/AUTO ScopeMeter Standard Kit (North America) (cont)

QTY	DESCRIPTION	MODEL	FLUKE PART NUMBER
1	Industrial Test Probe		
1	Red	TP20 - R	837807
1	Black	TP20 - B	837799
1	Grey	TP20 - G	928002
	Banana Plug Adapter, 4 mm		
1	Red	4mm Adapter Rd	162813
1	Black	4mm Adapter Bl	162821
1	Grey	4mm Adapter Gr	933866
1	Back Probe Pins	-	-

ACCESSORY KIT CONTENTS

Table 8B-2. 97/AUTO ScopeMeter Accessory Kit (North America)

QTY	DESCRIPTION	MODEL	FLUKE PART NUMBER
1	Carrying Case, Hard	K97A-7601	932822
1	Accessory Case, Soft	C75	865535
1	10:1 Probe, 8 ft, Red	-	935374
1	Low Pass Filter Probe (10:1)	-	933825
1	Capacitive Secondary Pickup	-	935379
	Test Lead Extension		
1	Red	-	933833
1	Black	-	933838
1	Grey	-	933841
2	Alligator Clip, Large Jaw	AC85A - Black	927756
1	Adapter, Dual Banana Jack to Male BNC	PM9082/001	916163
	Probe Tip Adapter, 4 mm Banana Plug		
1	Red	-	933846
1	Grey	-	933853



Table 8B-2. 97/AUTO ScopeMeter Accessory Kit (North America) (cont)

QTY	DESCRIPTION	MODEL	FLUKE PART NUMBER
1	Mini Testhook, 10 inch Red	-	933858
1	Grey	-	933861
1	Hook Style Clip Set (Red, Grey)	PM9085/001	916168
1	Trim Screwdriver Red	-	922091
1	Grey	-	922088
1	Probe Tip Adapter, 2 mm Red	-	922117
1	Grey	-	922120
1	RS-232-C Interface Adapter	PM9080/001	916148

OPTIONAL ACCESSORIES

Table 8B-3. Optional Accessories (North America)

QTY	DESCRIPTION	MODEL	FLUKE PART NUMBER
1	Pressure/Vacuum Transducer	PV500	919816
1	Clamp-On AC/DC Current Probe	80i-1010	796052
1	Universal Temperature Probe	80T-150U	779363

Appendix 8C

Warranty and Service Centers

Warranty Information

Congratulations on your purchase of a Fluke ScopeMeter®, which is designed to give you years of troublefree service. The following LIMITED WARRANTY covers your ScopeMeter for a period of three years and accessories provided with your ScopeMeter for a period of one year.

Please record date of purchase and your instrument serial number from the back of your ScopeMeter. Keep this information and your purchase invoice in a safe place separate from your ScopeMeter.

Date of purchase _____ Serial number _____

Statement of Calibration Practice

This ScopeMeter® has been calibrated using standards and instruments the accuracy of which is traceable to the National Institute of Technology and Standards (NIST) in the USA or to nationally accepted measuring systems. The standards and instruments used in calibration are supported by a calibration system which meets or exceeds the requirements of MIL-STD-45662.

A serialized and dated Certificate of Calibration for any individual instrument can be obtained from any Fluke Technical Service Center listed in the Users Manual. A nominal calibration fee will be charged.

Corporate Quality Assurance

LIMITED WARRANTY

Fluke warrants to the original product purchaser that each product it manufactures will be free from defects in material and workmanship under normal use and service. The warranty period is controlled by the warranty document furnished with each product and begins on the date of shipment. Fluke's warranty does not apply to fuses, batteries, CRTs or any product which, in Fluke's opinion, has been misused, altered, neglected, or damaged by accident or abnormal conditions of operation or handling.

To obtain warranty service, contact your nearest Fluke Service Center or send the product, with a description of the difficulty, postage and insurance prepaid, to the nearest Fluke Service Center. Fluke assumes no risk for damage in transit. Fluke will, at its option, repair or replace the defective product free of charge or refund your purchase price. However, if Fluke determines that the failure was caused by misuse, alteration, accident or abnormal condition of operation or handling, you will be billed for the repair and the repaired product will be returned to you transportation prepaid.

THIS WARRANTY IS EXCLUSIVE AND IS IN LIEU OF ALL OTHER WARRANTIES, EXPRESS OR IMPLIED, INCLUDING BUT NOT LIMITED TO ANY IMPLIED WARRANTY OR MERCHANTABILITY OR FITNESS FOR A PARTICULAR PURPOSE OR USE. FLUKE WILL NOT BE LIABLE FOR ANY SPECIAL, INDIRECT, INCIDENTAL, OR CONSEQUENTIAL DAMAGES OR LOSS OF DATA, WHETHER IN CONTRACT, TORT, OR OTHERWISE.

Some states do not allow the exclusion or limitation of incidental or consequential damages, or implied warranty periods, so the above limitations may not apply to you. Other rights may vary from state to state.

For application or operation assistance or information on Fluke products, call:

800-426-0361 in most of U.S.A.
206-356-5400 from AK and WA
306-356-5500 from other countries

John Fluke Mfg. Co., Inc.
P.O. Box 9090
Everett, WA 98206-9090

**USA**

California
Fluke Technical Center
46610 Landing Parkway
Fremont, CA 94538
TEL: (415) 651-5112:

Fluke Technical Center
16715 Von Karman Avenue
Suite 110
Irvine, CA 92714
TEL: (714) 863-9031

Florida
Fluke Technical Center
550 S. North Lake Blvd.
Altamonte Springs, FL 32701-5227
TEL: (407) 331-2929
TLX: (810) 850-0185

Illinois
Fluke Technical Center
1150 W. Euclid Avenue
Palatine, IL 60067
TEL: (708) 705-0500
TLX: (708) 705-0064

New Jersey
Fluke Technical Center
East 66 Midland Avenue
Paramus, NJ 07652-0930
TEL: (201) 599-9500

Texas
Fluke Technical Center
2104 Hutton Drive
Suite 112
Carrollton, TX 75006
TEL: (214) 406-1000

Washington
Fluke Technical Center
John Fluke Mfg. Co., Inc.
M/S 6-30
Everett WA 98203
TEL: (206) 356-5560
TLX: 185249

INTERNATIONAL

Argentina
Coasin S.A.
Virrey del Pino 4071 DPTO E-65
1430 CAP FED
Buenos Aires
TEL: 54 1 522-5248
TLX: (390) 22284 COASN AR

Australia
Phillips Customer Support
Scientific and Industrial
23 Lakeside Drive
Tally Ho Technology Park
East Burwood
Victoria 3151

Phillips Customer Support
Scientific and Industrial
25-27 Paul St. North
North Ryde, N.S.W. 2113
TEL: 61 2 888-8222
TLX: (790) AA20165
AUSNRSI+PHILIND

Austria
Oesterreichische Phillips Industrie
Unternehmensbereich Prof. Systeme
Gutheil Schoder
Gasse 10
A-1102 Wein
TEL: 43 222-60101x1388
TLX: 133129

Belgium
Phillips Professional System S.A.
I & E Division
Service Department
80, Rue des Deux Gares
B-1070 Brussels
TEL: 32 2 525-6111
TLX: (846) 61511 BELBRMS

Brazil
Hi-Tek Electronica Ltda.
Al. Amazonas 422, Alphaville
CEP 06400 Barueri
Sao Paulo
TEL: 55 011 421-5477
TLX: (391) 11 71413 HITK B

Canada
Fluke Electronics Canada Inc.
400 Britannia Road East, Unit #1
Mississauga, Ontario
L4Z 1X9
TEL: 416 890-7600

Chile
Intrinsa Inc.
Casilla 16228
Santiago 9
TEL: 56 2 232-1886, 232-4308
TLX: (332) 346351 INTRON CK

China
Fluke Service Center
Room 2111 Scite Tower
Jianguomenwai Dajie
Beijing 100004, PRC
TEL: 86 1 512-3436 or 6351
TLX: (716) 222529 FLUKE CN

Colombia
Sistemas E Instrumentacion, Ltda.
Carrera 21, NO. 39A-21, OF. 101
Ap. Aereo 29583
Bogota
TEL: 57 287-5424

Costa Rica
Electronic Engineering, S.A.
Carretera de Circunvalacion
Sabanilla Av. Novena
San Jose
TEL: 506-53-3759

Denmark
Phillips Eleltronix Systemer A/S
Strandlodsvej 4B
DK 2300
Copenhagen
TEL: 45 32 882531
TLX: 31201 phil dk

Ecuador
Proteco Coasin Cia., Ltda.
P.O. Box 17-03-228-A
Ave. 12 de Octubre
2449 y Orellana
Quito
TEL: 593 2 230283 or 520005
TLX: (393) 22085 PROTECED

Egypt
Phillips Egypt
10, Abdel Rahman el Rafei st.
el. Mohandessin
P.O. Box 242
Dokki Cairo
TEL: 20 2 490922
TLX: 22816 phegy un

97/AUTO

Users Manual

England
Phillips Scientific
Test & Measuring Division
Colonial Way
Wattford
Hertfordshire WD2 4TT
TEL: 44 923-240511
TLX: (851) 934583 PHI TMD

Federal Republic of Germany
Phillips GmbH
Service VSF
Unternehmensbereich Elektronik
für Wissenschaft und Industrie
Oskar-Messterstrasse 18
D-8045 Ismaning/Munich
TEL: 49 89 9605

Finland
Oy Phillips AB
Central Service
Sinikalliontie 1-3
P.O. Box 11
02631 ESPOO
TEL: 358 0 502-6200
TLX: 121875 fixheps

France
S.A. Phillips Industrielle et
Commerciale,
Science et Industrie
105 Rue de Paris BP 62
93002 Bobigny, Cedex
TEL: 33-1-4942-8040
TLX: 210290 induphi

Greece
Phillips S.A. Hellenique
15,25th March Street
177 78 Tavros
10210 Athens
TEL: 30 1 4894911
TLX: 241566/241567 frtgra

Hong Kong
Schmidt & Co (H.K.) Ltd.
18/FL., Great Eagle Centre
23 Harbour Road
Wanchai
TEL: 852 507-0222
TLX: (780) 76762 SCHMC HX

India
Hinditron Services Pvt. Inc.
33/44A Raj Mahal Vilas Extension
8th Main Road
Bangalore 560 080
TEL: 91 812 348-266 or 340-068
TLX: (953) 845271 HSPIL IN

Hinditron Services Pvt. Ltd
1st Floor, 17-B,
Mahal Industrial Estate
Mahakali Road, Andheri East
Bombay 400 093
TEL: 91 22 6300043
TLX: (953) 11-79387 HEMC IN

Hinditron Services Pvt. Ltd.
15 Community Centre
Panchshila Park
New Delhi 110 017
TEL: 91 011 643-3675
TLX: (953) 031-61458 HCPL I

Hinditron Services Pvt. Ltd.
Field Service Center
Emerald Complex 1-7-264
5th Floor
114 Sarojini Devi Road
Secunderabad 500 003
TEL: 91 842-844033
TLX: (953) 425-6973

Indonesia
P. T. Daeng Brothers
Phillips House
J1. Rasuna Said Kav. 3-4
Jakarta 12950
TEL: 62 21 520 1122
TLX: (792) 62189 PHDC IA

Israel
R.D.T Electronics Engineering, Ltd.
P.O. Box 58013
Tel Aviv 61580
TEL: 972-3-5483737
TLX: (922) 371452 RDT IL

Italy
Phillips S.P.A.
Sezione I&E / T&M
Viale Elvezia 2
20052 Monza
TEL: 39-39-203-6525
TLX: 333343 phiils i

Japan
Fluke Corporation
Sumitomo Higashi Shinbashi Bldg.
1-1-11 Hamamatsucho
Minato-ku
Tokyo 105
TEL: 81 3 3434-0181
TLX: (781) 2424331 FLUKJJP

Korea
Myoung Corporation
Yeo Eui Do P.O. Box 14
Seoul 150
TEL: 82 2 784-9942
TLX: (787) 24283 MYOUNG

Malaysia
Mecomb Malaysia Sdn. Bhd.
P.O. Box 24
46700 Petaling Jaya
Selangor
TEL: 60 3 774-3422
TLX: (784) MA37764 MECOMB

Mexico
Mexel Mexicana De Electronica
Industrial, S.A. De C.V.
Calle Diagonal #27 3er.
Col. Del Valle
C.P. 03100, Mexico D.F.
TEL: 52-5-682-8040
TLX: 1171038 FAIRME

Netherlands
Phillips Nederland
Dep. Technical Service Prof. Act.
P.O. Box 218
Building HBR
5600 MD Eindhoven
TEL: 31-40-503110
TLX: 51238

New Zealand
Phillips Customer Support
Scientific & Industrial
2 Wagener Place Mt. Albert
Private Bag, St. Lukes
Auckland 3
TEL: 64 9 894-160
TLX: (791) NZ 2395



Norway
Norsk A/S Phillips
I&E Service
Sandstuveien 70
Postboks 1 Manglerud
N 0680 OSLO 6
TEL: 47-2-748-408
TLX: 72640 phlps n

Peru
Importaciones & Representaciones
Electronicas S.A.
Avad Franklin D. Roosevelt 105
Lima 1
TEL: 51 14 288650
TLX: (394) 25663 PE IREING

Philippines
Spark Electronics Corp.
P.O. Box 610, Greenhills
Metro Manila 1502
TEL: 63 2 700-621
TLX: (722) 4005 RLA PH PU

Portugal
Phillips Portuguese S.A.
I&E Division
Outurela 7
P.O. Box 55
2795 LINDA-A-VELHA
TEL: 351 1 4170071
TLX: 65120 PTLPGAJ

Republic of South Africa
South African Phillips (Pty) Ltd.
I&E Service Mgr.
P. O. BOX 7703
Johannesburg 2000
TEL: 27 11 889-3911
TLX:(960) 4-26152 SA

Singapore
Rank O'Connor's Singapore Pte Ltd
98 Pasir Panjang Road
Singapore 0511
TEL: 65 4737944
TLX: (786) RS21023 OCONSIN

Spain
Phillips Iberica Sae
Depto. Tecnico Instrumentacion
c/Martinez Villergas 2
28027 Madrid
TEL: 34 1 4042314
TLX: 052-27710 dsxm/eesm/op

Sweden
Phillips Kistaindustri AB
I&E Technical Customer Support
Borgarfjordsgatan 16
S 164 93 Kista
TEL: 46-8-782-1300
TLX: 854 17173 PHILKI S

Switzerland
Phillips Industrial Electronics
Test and Messtechnik
Riedstrasse 12
Postfach 360
CH-8953 Dietikon
TEL: 41 1 745-2244
TLX: (845) 8157780-0

Taiwan, R.O.C.
Schmidt Electronics Corp.
5th Floor, Cathay Min Sheng
Commercial Building,
344 Min Sheng East Road
Taipei
TEL: 886 2 501-3468
TLX: (785) 11111 SCHMIDT

Thailand
Measuretronix Ltd.
2102/31 Ramkamhaeng Road
Bangkok 10240
TEL: 66 2 375-2733,375-2734
TLX: (788) 82796 HUAMARK TH

Turkey
Turk Phillips Ticaret A.S.
Inonu Caddesi 78/80
Posta Kutusu 504-Beyoglu
Istanbul
TEL: 90 1 1435891
TLX: 24192 phtr trtrxbph

Uruguay
Coasin Uruguay S.A.
Casilla de Correo 1400
Libertad 2525
Montevideo
TEL: 598-2-789015
TLX: (398) COAUR UY23010

Venezuela
Coasin C.A.
Calle 9 Con Calle 4, Edif. Edinurbi
Apartado de Correos Nr-70-136
Los Ruices
Caracas 1070-A
TEL: 58 2 241-0309, 241-1248
TLX: (395) 21027 EMVEN VC

Appendix 8D

Terminology

ABS Antilock Brake System.

AC See "Alternating Current."

AC Sine Wave The waveform defined by an AC electrical signal.

Activate The steps necessary to turn on a feature or function.

Alternating Current An electrical signal with the same number of positive and negative peaks.

ALTFLD Alternator Field signal.

Amplitude The difference between the highest and lowest voltage displayed.

Attenuation The decrease in amplitude of a signal.

Autoset A feature that allows ScopeMeter to sample the incoming electrical signal, and adjusts the Voltage Scale and Time Base to display a readable signal.

Backlight A light that brightens ScopeMeter's Display.

Bandwidth The range of Frequencies that transmit a signal.

Bank injection All of the injectors in a group or bank firing at the same time. See "Group Injection."

Base Voltage Beginning or starting voltage level.

BCM Body Control Module.

BNC A type of electrical connector.

Bottom Display The lower part of ScopeMeter's Display, where the Softkey functions are listed.

BPW Base Pulse Width.

Capacitor A device for storing electricity, often used to eliminate noise from electrical signals.

Capture To record a signal or voltage in memory.

Capture 20 Divisions A feature that allows ScopeMeter to record and display 20 time divisions, although the Display only shows 10 at a time. "Move" allows you to view the additional 10 divisions.

CFI Computerized Fuel Injection.

Choke A device for filtering alternating current out of a circuit.

Condenser See "Capacitor."

CPS Crankshaft Position Sensor.

CS Charging System (prefix).

CTS Coolant Temperature Sensor.

Cursor A movable display pointer that allows you to choose specific areas of a waveform for measurement.

Cursor Data A feature for measuring specific areas of a waveform for voltage, Frequency, Pulse Width, Dwell, and so on.

Cycle One complete set of changes in a recurring signal.

DC See "Direct Current."

Deactivate A series of steps necessary to turn off a feature or function.

Delta Time The change in time. When chosen from the Cursor menu, ScopeMeter displays the amount of time displayed between the Cursors.

Digital Storage Capability Because of the design of digital oscilloscopes, signals are not displayed as they are read. Instead, the signals are stored in memory, then are sent to the Display. This enables ScopeMeter to present several options when displaying information, including "negative delay."

Diode An electrical device that allows current to flow in one direction only.

Direct Current A current flow of basically constant value.

DIS Distributorless Ignition System.

Division A specific segment of a waveform, as defined by the grid on ScopeMeter's Display.

DREF Distributor Reference Voltage.

Dual Trace A feature that allows ScopeMeter to display two separate live waveforms at the same time.

Duty Cycle Relative on-time to total on/off-time, as measured in Percentage of Pulse Width or Degrees of Dwell.

DWLCT Dwell Control signal.



ECA Electronic Control Assembly.

ECM Electronic Control Module.

ECM Driver Transistor Internal computer device that provides ground to complete the circuit for fuel injectors.

ECU Electronic Control Unit.

EFI Electronic Fuel Injection.

EGR Exhaust Gas Recirculating.

EMI Electromagnetic Interference.

EST Electronic Spark Timing.

Falling Edge The part of a waveform that shows the voltage decreasing.

Feed Controlled Circuit A circuit that energizes by applying voltage; it already has a ground.

Filter Electrical device that reduces or removes electrical interference from a circuit.

Free Run Feature that allows ScopeMeter to display a waveform without a Trigger.

Freeze To stop a waveform display for closer examination.

Frequency The number of complete oscillations that occur during one second, measured in Hertz (Hz).

Glitch A momentary disruption in the electrical circuit; indicates a problem in the circuit.

Ground-controlled Circuit A circuit that energizes by applying ground; voltage is already supplied.

Ground Trace The part of a waveform that defines the circuit ground.

Group Injection A type of fuel injection circuit that fires more than one injector at a time. See "Bank Injection."

Hall Effect Sensor A semiconductor moving relative to a magnetic field, creating a variable voltage output.

Hardkeys ScopeMeter keys that have the same function, regardless of ScopeMeter's mode.

HDR High Data Rate signal.

HEI High Energy Ignition

Hertz Unit of measure for counting the number of times an electrical cycle repeats every second. One Hertz is one pulse each second.

Hold Feature A feature of ScopeMeter that allows you to freeze the Display for closer examination.

IACV Idle Air Control valve.

IDM Ignition Diagnostic Monitor.

Ignition Reference Signal Signal used by the ECM to determine engine RPM and crankshaft position. Allows ECM to time fuel injection, spark timing, and dwell signals to the engine.

Inductance Current flow that is the direct result of the current through a nearby circuit.

INSIG Ignition Signal.

Intermittent Irregular; a condition that happens with no apparent or predictable pattern.

Interrupter A device that blocks a signal.

Lab Scope A device for viewing electrical signals as waveforms; usually not portable.

LCD See "Liquid Crystal Display."

Leads Electrical conductors that connect ScopeMeter to a circuit.

Liquid Crystal Display An electronic display that energizes liquid crystals to draw on its screen and provide information.

MAF Mass Air Flow.

Map Following and plotting a signal over a period of time.

MAP Sensor Manifold Absolute Pressure Sensor. A device for measuring engine vacuum.

Master Reset Procedure to restore ScopeMeter to its factory settings.

Maximum Peak The highest voltage recorded over a specific time period.

Menu A list of choices for selecting a configuration or feature.

Menu Driven Interface A method of communicating with ScopeMeter. Instead of dozens of switches and dials, ScopeMeter provides you with a menu or a series of choices. Each choice narrows ScopeMeter's settings, until you achieve the precise settings necessary for a test procedure.

Message Bar A way for ScopeMeter to display information about a command condition.

Meter Mode In this setting, ScopeMeter works like a digital multimeter, presenting information in a digital readout.

Midway A point centered between two other points.

MIN-MAX Feature of ScopeMeter that increases its sampling rate to the maximum level.

Minimum Peak The lowest voltage recorded over a specific time period.

Noise Extraneous electrical signal that can interfere with other electrical signals.



Non-Repetitive Pulse A random electrical signal, with no specific pattern or Frequency.

O2 Oxygen Sensor Signal.

Off-time The part of an electrical signal during which an electrical device is de-energized.

On-time The part of an electrical signal during which an electrical device is energized.

One-to-One Probe An electrical test probe without any built-in resistance. For example, the 1:1 test leads.

Oscillations The up-and-down peaks of a waveform. One oscillation consists of one complete up-peak and one complete down-peak of a trace.

Oscilloscope A device for viewing and diagnosing electrical signals as waveforms.

PCM Powertrain Control Module.

Peak-and-Hold A method for regulating the current flow through electronic fuel injectors. Supplies the higher current necessary to energize the injector, then drops to a lower level just enough to keep the injector energized.

Peak-to-Peak A feature of ScopeMeter for measuring the highest and lowest voltage measured over a specific period of time.

Percentage of Pulse Width The ratio of signal on-time to its total cycle time, as measured in percent.

PIP Profile Ignition Pick-up.

Pop-up Menu A list of choices displayed along ScopeMeter's Right Display for configuring a setup or choosing a feature.

Probe Calibration A procedure to allow ScopeMeter to adjust internally to compensate for resistance variations between probes.

Probes An electrical conductor that connects ScopeMeter to a circuit; specifically for use in the BNC jacks.

Pulse A voltage signal that increases from a constant value, then decreases to its original value.

Pulse Modulated A circuit that maintains average voltage levels by pulsing the voltage on and off.

Pulse Rate The number of pulses that take place over a specific amount of time.

Pulse Trains A repetitive series of pulses.

Pulse Width The duration from the beginning to the end of a signal's on-time or off-time.

Pulse Width Percentage See "Percentage of Pulse Width."

PWM Pulse Width Modulation.

QDM Quad Driver Module.

Range The quantity between two points or levels.

Recall The process of loading a stored setup or waveform back into ScopeMeter.

Record A feature that allows ScopeMeter to draw a new trace without erasing earlier traces. This allows you to capture momentary glitches without having to monitor the signal constantly.

Reference Voltage An unaltered voltage applied to a circuit.

Repetitive Pulse A signal with a regular pattern or Frequency.

Right Menu A display area listing existing conditions about ScopeMeter, and a location for Pop-up menus.

Rising Edge The part of a waveform displaying a rise in voltage.

RMS See "Root Mean Square."

Root Mean Square A formula that converts AC voltages to a comparable value in DC.

Samples A reading taken from an electrical signal. Digital oscilloscopes take a series of samples to display a waveform.

Sampling Rate The number of readings taken from an electrical signal every second. ScopeMeter can take up to 25,000,000 samples from an electrical signal every second.

Saturated Driver Fuel injection circuit that maintains the same voltage level throughout its on-time; conventional injection system.

Scope Mode In this setting, ScopeMeter works like an oscilloscope and presents information in a digital scope format.

Sequential Injection Fuel injection system where the injectors fire from individual drivers, in the same sequence as the engine firing order.

Setup Series of adjustments necessary for ScopeMeter to display a waveform or reading.

Setup Memories A feature that allows ScopeMeter to save an existing setup for use later.

Signature Voltage Signal Waveform characteristic that makes it possible to distinguish from other, similar waveforms. Caused by the circuit's unique configuration.



Softkeys ScopeMeter keys that change function based on the current mode or settings. Softkey definitions appear on the Bottom Display.

SPOUT Spark Output Signal to TFI Module.

Square Wave A digital signal characterized by its square, clean transitions. This waveform defines an electrical signal that is either on or off.

TCC Torque Converter Clutch.

Ten-to-One Probe An electrical probe with a resistance high enough to reduce the incoming electrical signal to one-tenth of its original voltage.

TFI Thick Film Ignition Module.

Threshold Level The level a voltage must attain to activate a circuit or component.

Throttle Position Sensor Device for measuring the throttle opening in a computer-controlled vehicle.

Time Base The time defined by each vertical division on ScopeMeter's Display.

Top Display The upper edge of the Display, where ScopeMeter lists probe calibration, Voltage Scale, Time Base, Voltage Coupling, and Trigger information.

TPS Throttle Position Sensor.

Trace The displayed image that defines the electrical signal.

Transition A point where a condition changes; a digital signal changes from "on" to "off" at its transition point.

Trigger A method of choosing when you want a trace to begin. Level, Slope, and Source are different ways to specify Trigger.

Trigger at 50% A feature that automatically sets ScopeMeter's Trigger Level half-way between the highest and lowest voltage recorded.

Trigger Delay The time after or before the voltage crosses the Trigger Level.

Trigger Level The voltage necessary for an oscilloscope to begin its trace.

Trigger Slope The voltage direction necessary for an oscilloscope to begin its trace. A positive Slope requires the voltage to be increasing as it crosses the Trigger Level. A negative Slope requires the voltage to be decreasing.

Trigger Source The signal that supplies ScopeMeter with its Trigger. This can be the signal being viewed, or it can come from another signal.

Voltage at One A feature that allows ScopeMeter to display the signal voltage directly under Cursor 1.

Voltage Coupling A setting that enables ScopeMeter to read a type of voltage. AC Coupling allows ScopeMeter to filter out the DC, and read only AC volts. DC Coupling allows it to read AC and DC voltage. Ground Coupling displays the ground trace.

Voltage Scale The voltage defined by each horizontal division on ScopeMeter's Display.

Voltage Spike A momentary increase or decrease in voltage.

VSS Vehicle Speed Sensor.

Waveform The pattern defined by an electrical signal.

WOT Wide Open Throttle.

Appendix 8E

Menu Trees

This appendix presents a series of charts showing the interrelationships of the softkey and pop-up menus. The charts are organized as follows:

- Figure 8E-1 presents menu sequences you will encounter only in Meter Mode.
- Figure 8E-2 presents menus only used with Scope Mode.
- Figure 8E-3 shows the set of menus used with both Meter and Scope Modes.

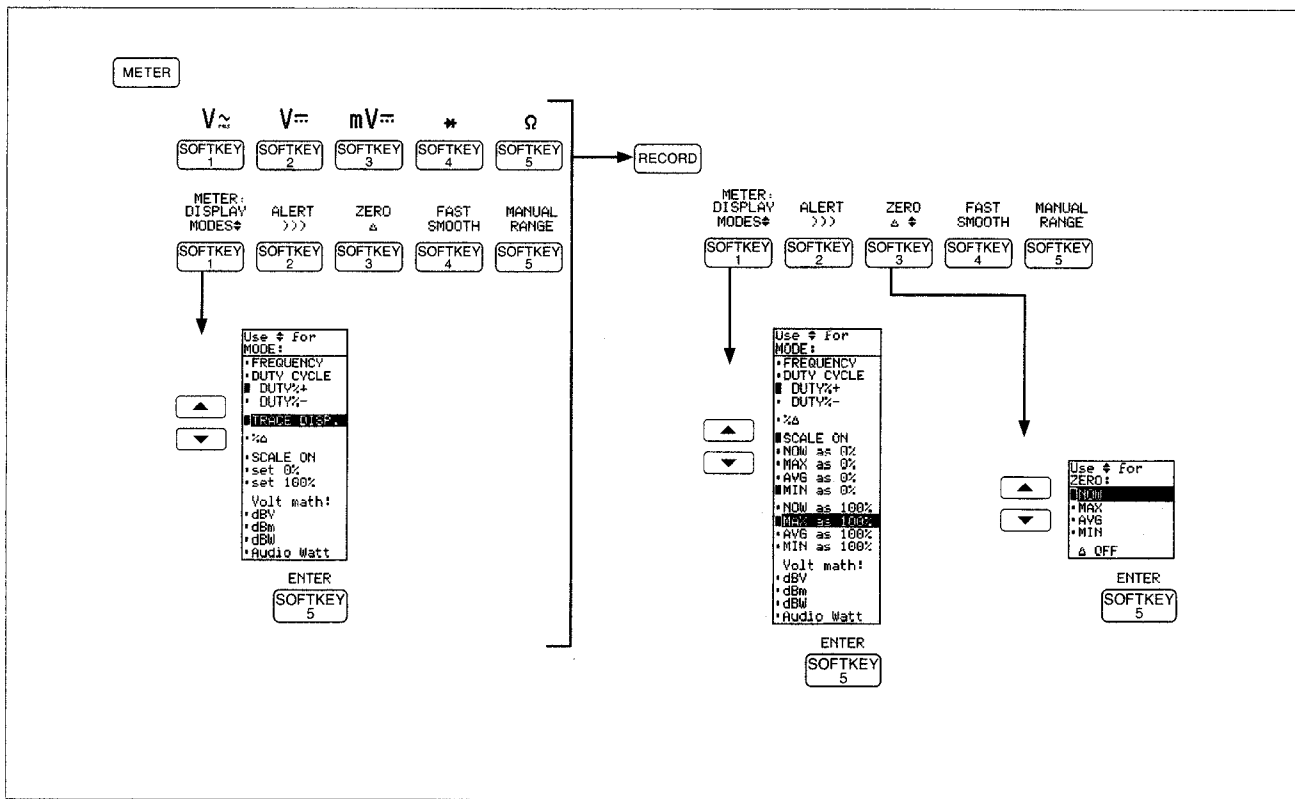

Figure 8E-1. Meter Mode Menus

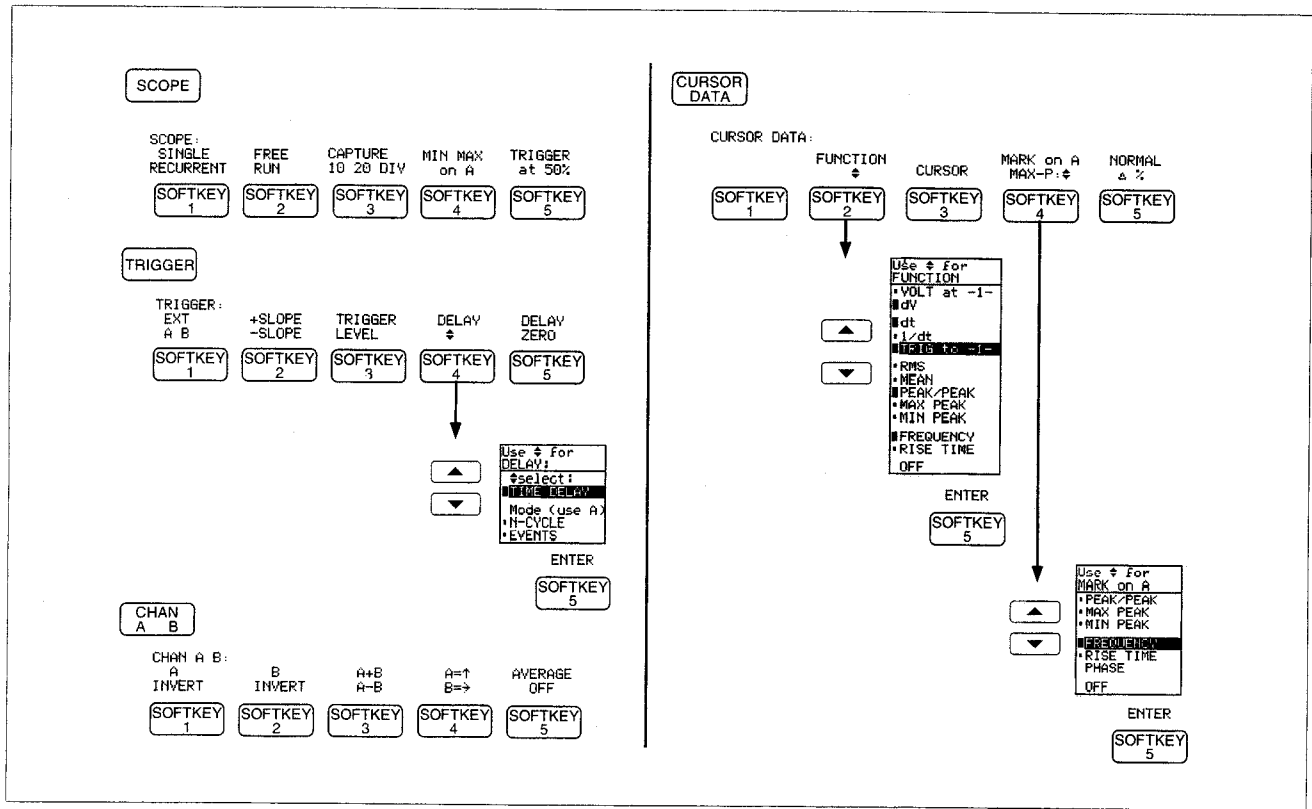

Figure 8E-2a. Scope Mode Menus

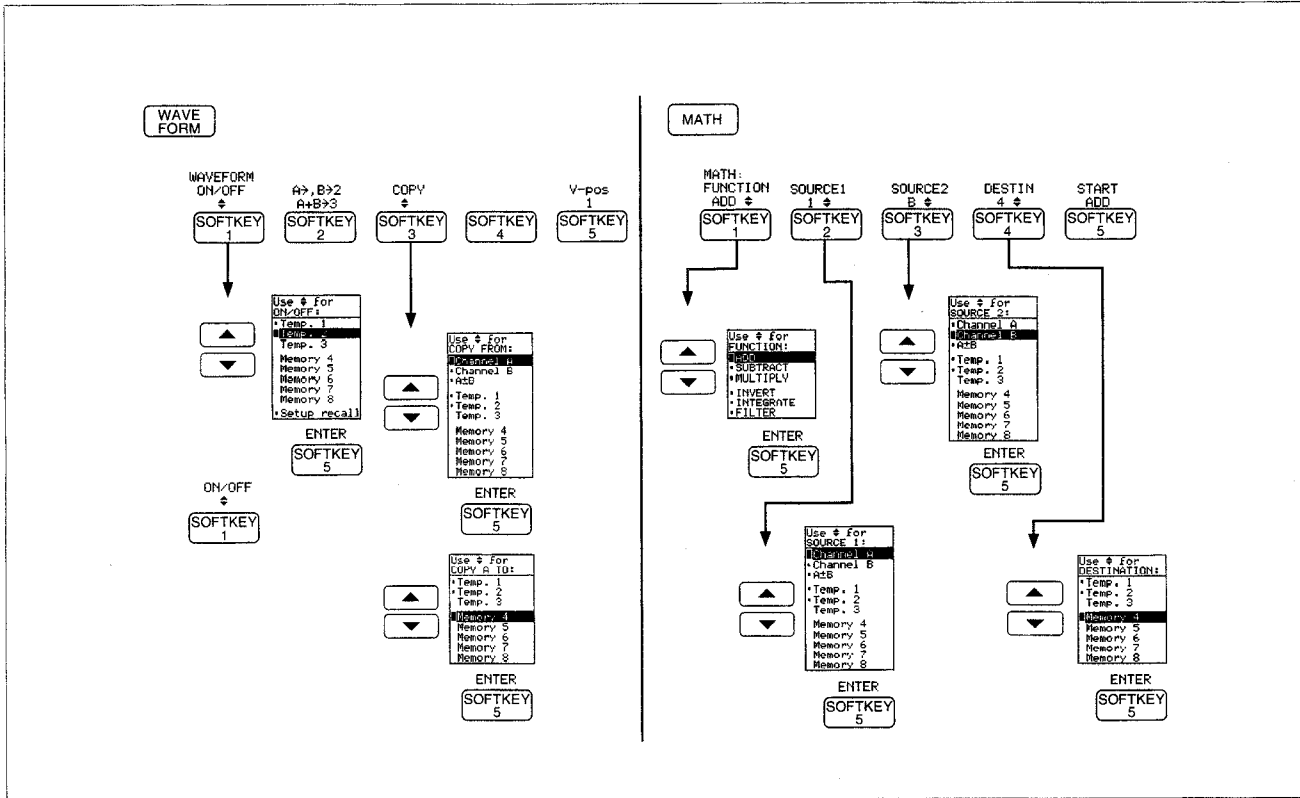

Figure 8E-2b. Scope Mode Menus

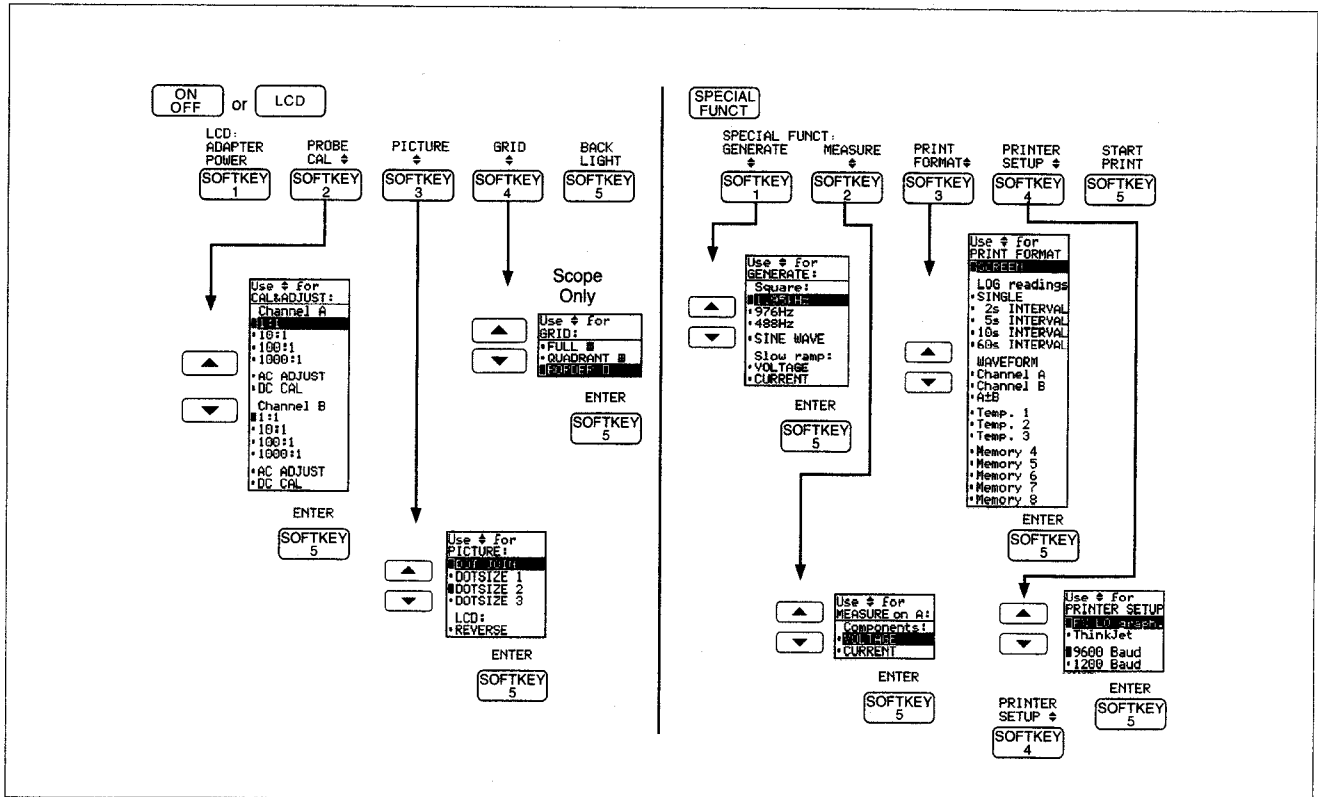

Figure 8E-3a. General Usage Menus

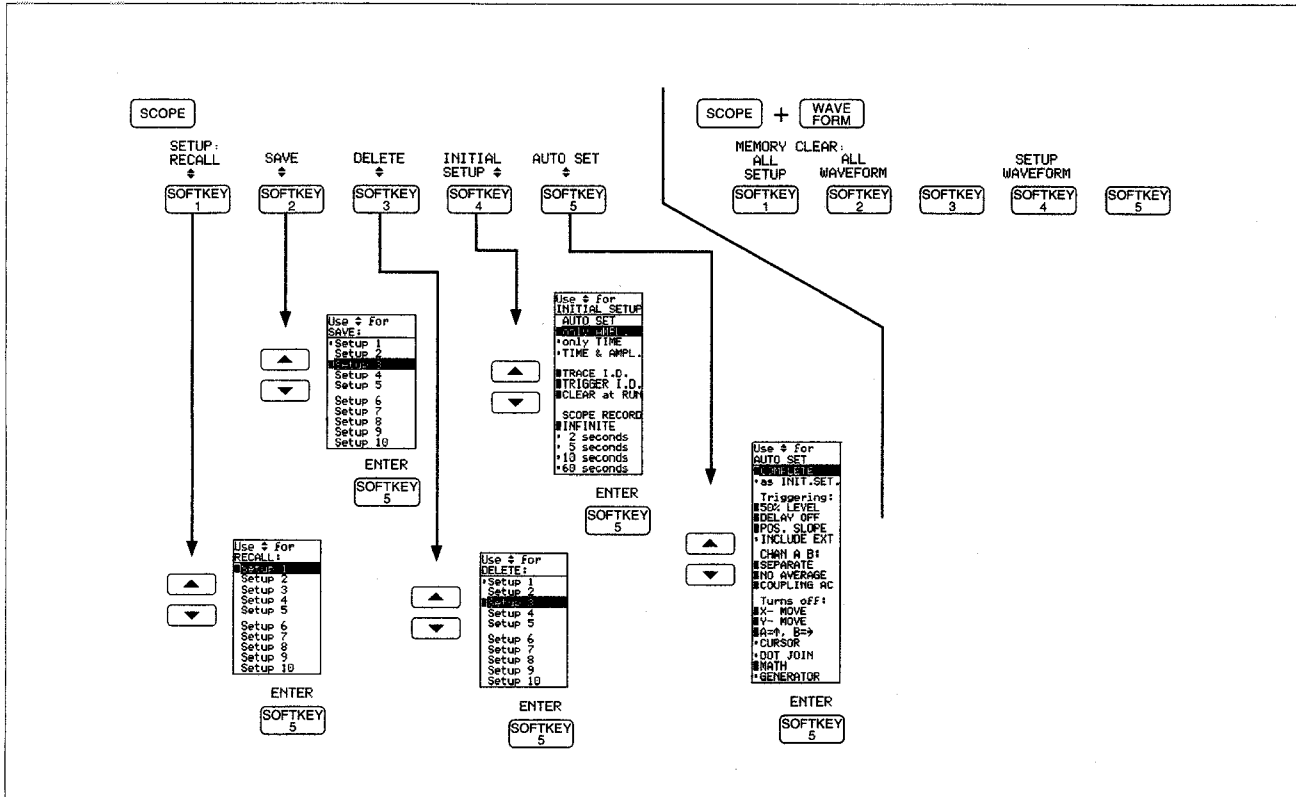

Figure 8E-3b. General Usage Menus

Appendix 8F

Duty Cycle to Dwell Conversion

Table 8F-1. Duty Cycle to Dwell Conversion

DUTY CYCLE (%)	DWELL (NO. OF CYLINDERS)				
	3	4	5	6	8
0	0.0	0.0	0.0	0.0	0.0
1	1.2	0.9	0.7	0.6	0.5
2	2.4	1.8	1.4	1.2	0.9
3	3.6	2.7	2.2	1.8	1.4
4	4.8	3.6	2.9	2.4	1.8
5	6.0	4.5	3.6	3.0	2.3
6	7.2	5.4	4.3	3.6	2.7
7	8.4	6.3	5.0	4.2	3.2
8	9.6	7.2	5.8	4.8	3.6
9	10.8	8.1	6.5	5.4	4.1
10	12.0	9.0	7.2	6.0	4.5

Table 8F-1. Duty Cycle to Dwell Conversion (cont)

DUTY CYCLE (%)	DWELL (NO. OF CYLINDERS)				
	3	4	5	6	8
11	13.2	9.9	7.9	6.6	5.0
12	14.4	10.8	8.6	7.2	5.4
13	15.6	11.7	9.4	7.8	5.9
14	16.8	12.6	10.1	8.4	6.3
15	18.0	13.5	10.8	9.0	6.8
16	19.2	14.4	11.5	9.6	7.2
17	20.4	15.3	12.2	10.2	7.7
18	21.6	16.2	13.0	10.8	8.1
19	22.8	17.1	13.7	11.4	8.6
20	24.0	18.0	14.4	12.0	9.0
21	25.2	18.9	15.1	12.6	9.5
22	26.4	19.8	15.8	13.2	9.9
23	27.6	20.7	16.6	13.8	10.4
24	28.8	21.6	17.3	14.4	10.8
25	30.0	22.5	18.0	15.0	11.3
26	31.2	23.4	18.7	15.6	11.7
27	32.4	24.3	19.4	16.2	12.2
28	33.6	25.2	20.2	16.8	12.6
29	34.8	26.1	20.9	17.4	13.1
30	36.0	27.0	21.6	18.0	13.5



Table 8F-1. Duty Cycle to Dwell Conversion (cont)

DUTY CYCLE (%)	DWELL (NO. OF CYLINDERS)				
	3	4	5	6	8
31	37.2	27.9	22.3	18.6	14.0
32	38.4	28.8	23.0	19.2	14.4
33	39.6	29.7	23.8	19.8	14.9
34	40.8	30.6	24.5	20.4	15.3
35	42.0	31.5	25.2	21.0	15.8
36	43.2	32.4	25.9	21.6	16.2
37	44.4	33.3	26.6	22.2	16.7
38	45.6	34.2	27.4	22.8	17.1
39	46.8	35.1	28.1	23.4	17.6
40	48.0	36.0	28.8	24.0	18.0
41	49.2	36.9	29.5	24.6	18.5
42	50.4	37.8	30.2	25.2	18.9
43	51.6	38.7	31.0	25.8	19.4
44	52.8	39.6	31.7	26.4	19.8
45	54.0	40.5	32.4	27.0	20.3
46	55.2	41.4	33.1	27.6	20.7
47	56.4	42.3	33.8	28.2	21.2
48	57.6	43.2	34.6	28.8	21.6
49	58.8	44.1	35.3	29.4	22.1
50	60.0	45.0	36.0	30.0	22.5

Table 8F-1. Duty Cycle to Dwell Conversion (cont)

DUTY CYCLE (%)	DWELL (NO. OF CYLINDERS)				
	3	4	5	6	8
51	61.2	45.9	36.7	30.6	23.0
52	62.4	46.8	37.4	31.2	23.4
53	63.6	47.7	38.2	31.8	23.9
54	64.8	48.6	38.9	32.4	24.3
55	66.0	49.5	39.6	33.0	24.8
56	67.2	50.4	40.3	33.6	25.2
57	68.4	51.3	41.0	34.2	25.7
58	69.6	52.2	41.8	34.8	26.1
59	70.8	53.1	42.5	35.4	26.6
60	72.0	54.0	43.2	36.0	27.0
61	73.2	54.9	43.9	36.6	27.5
62	74.4	55.8	44.6	37.2	27.9
63	75.6	56.7	45.4	37.8	28.4
64	76.8	57.6	46.1	38.4	28.8
65	78.0	58.5	46.8	39.0	29.3
66	79.2	59.4	47.5	39.6	29.7
67	80.4	60.3	48.2	40.2	30.2
68	81.6	61.2	49.0	40.8	30.6
69	82.8	62.1	49.7	41.4	31.1
70	84.0	63.0	50.4	42.0	31.5



Table 8F-1. Duty Cycle to Dwell Conversion (cont)

DUTY CYCLE (%)	DWELL (NO. OF CYLINDERS)				
	3	4	5	6	8
71	85.2	63.9	51.1	42.6	32.0
72	86.4	64.8	51.8	43.2	32.4
73	87.6	65.7	52.6	43.8	32.9
74	88.8	66.6	53.3	44.4	33.3
75	90.0	67.5	54.0	45.0	33.8
76	91.2	68.4	54.7	45.6	34.2
77	92.4	69.3	55.4	46.2	34.7
78	93.6	70.2	56.2	46.8	35.1
79	94.8	71.1	56.9	47.4	35.6
80	96.0	72.0	57.6	48.0	36.0
81	97.2	72.9	58.3	48.6	36.5
82	98.4	73.8	59.0	49.2	36.9
83	99.6	74.7	59.8	49.8	37.4
84	100.8	75.6	60.5	50.4	37.8
85	102.0	76.5	61.2	51.0	38.3
86	103.2	77.4	61.9	51.6	38.7
87	104.4	78.3	62.6	52.2	39.2
88	105.6	79.2	63.4	52.8	39.6
89	106.8	80.1	64.1	53.4	40.1
90	108.0	81.0	64.8	54.0	40.5

Table 8F-1. Duty Cycle to Dwell Conversion (cont)

DUTY CYCLE (%)	DWELL (NO. OF CYLINDERS)				
	3	4	5	6	8
91	109.2	81.9	65.5	54.6	41.0
92	110.4	82.8	66.2	55.2	41.4
93	111.6	83.7	67.0	55.8	41.9
94	112.8	84.6	67.7	56.4	42.3
95	114.0	85.5	68.4	57.0	42.8
96	115.2	86.4	69.1	57.6	43.2
97	116.4	87.3	69.8	58.2	43.7
98	117.6	88.2	70.6	58.8	44.1
99	118.8	89.1	71.3	59.4	44.6
100	120.0	90.0	72.0	60.0	45.0

INDEX

10:1 Probes, 7-7
1/dt, 3-21
80i-1010 DC/AC Current Probe, 6-8
80T-150U, 6-5
97/AUTO ScopeMeter Accessory Kit (North America) (table), 8-16 to 8-17
97/AUTO ScopeMeter Standard Kit (North America) (table), 8-13 to 8-15

A

A+B, 3-18, 4-16
A-B, 3-18, 4-16
AC Adjustment, 7-8
Accessory Kit, 8-16 to 8-17
Acquisition, 3-5, 3-13
Acquisition memories, 4-18
ADD, 4-21
Advanced Applications, 6-1
Alert, 2-12
Alternator Ripple Voltage, 5-2
Alternator Test, 5-2
Amplitude, 3-13

Applications, 5-1
Attenuator, 2-9, 3-14, 4-5
Audio Watt, 4-13
Auto Range, 2-10
AUTOSSET, 1-32
Auto Set, 1-29
Autoset, 3-14
Auto Set Pop-Up Menu, 4-6
Auto Setup Pop-Up Menu, 4-7
Averaging, 2-12, 3-17

B

Backlight, 1-12
Battery Charging, 1-5
Battery Replacement (figure), 7-3
Battery Save Feature, 1-5
Baud, 4-3
BORDER Grid, 1-16
Bottom Display (Softkey Menu), 1-7

C

Calibration, 7-7
Capacitive Pickup, 6-2
CAPTURE 10 20 Div, 3-7
Caution Statements, iv
Channel Math, 4-16
Channel Selection, 3-16
Channel Softkey Menu, 3-16, 4-17
Choosing a Time Base (table), 3-26
Clamping Diode Test, 5-5
Clamping/Suppression Diodes, 5-5
Cleaning, 7-2
Clearing Memory, 4-8
Clear Setup Memory, 4-8
Clear Waveform Memory, 4-8
Common Ground, Channels A B, 1-18
Common (Ground) Connections, v
Component Measurement, 1-18
Component Measurement Pop-Up Menu, 4-8
Configuring Autoset, 4-5
Continuity testing, 2-12
Contrast, 1-12
Coolant Temperature Sensor (CTS), 6-5
Coupling, 2-5, 3-12
Crankshaft Position Sensor, 5-26, 5-32
Current Measurements, 6-8
Cursor Data Softkey Menu, 3-20 to 3-21
Cursor Function, 3-20
Cursor Function Pop-Up Menu, 3-21

Cursor Marker Pop-Up Menu, 3-23
Cursor Positioning, 3-23
Cursor Source, 3-20

D

dBm, 4-13
dBV, 4-13
dBW, 4-13
DC Calibration, 7-8
Delay Zero, 3-12
DELETE, 1-32
Delete Setup, 1-32
Delta, 2-12
Delta Formula, 4-11
Destination, 4-21
Diode Test, 2-7, 5-2, 5-5
Direct Printing, 4-3
Display, 1-12
Display Hold, 2-13, 4-24
Displaying Multiple Waveforms, 3-18
Display in Scope Mode (figure), 1-6
Display Items, iii
Display Modes, 2-10, 4-10
Distributors, 5-32
Dot Join, 1-13
Dot Size, 1-13
dt, 3-20
dv, 3-20
Duty Cycle +/-, 2-11, 4-10
Duty Cycle To Dwell Conversion (Appendix 8F),
8-39

E

Electrical Interference (RFI or EMI on Ground or Feed), 5-36
 EMI Test, 5-36
 Events, 3-12
 External Trigger, 1-18, 3-12, 6-2

F

FAST (refresh rate), 2-12
 FILTER, 4-21, 4-23
 Free Run, 3-5, 3-7
 FREQUENCY, 2-11, 3-21
 Fuel Injector Pulse Width, 5-19
 Fuel Injector Test, 5-19, 5-39
 FULL Grid, 1-16
 Functions and Ranges, 2-4
 Fuse Replacement, 7-4

G

General Maintenance, 7-2
 Generator Pop-Up Menu, 4-9
 Grid, 1-15
 Grid Pop-Up Menu (figure), 1-15

H

Hall Effect Sensors, 5-32
 Hall Effort Sensor Test, 5-32
 Hardkeys, 1-10
 Help, 3-24
 Holster, 1-2

I

Ignition Testing, 6-2
 Inductive Pickup, 6-2
 INIT. SET, 4-5
 INITIAL SETUP, 1-32
 Initial Setup Pop-Up Menu, 4-5
 Input coupling, 2-5, 3-12
 Input/Output Terminal Ratings, 1-18
 INTEGRATE, 4-21, 4-23
 Interface, 1-18, 4-2
 International Electrical Symbols, v
 INVERT, 4-21

K

Keys, 1-10
 Keystrokes, iii
 Knock Sensor (Piezo Crystal), 5-16
 Knock Sensor Test, 5-16

L

LCD Softkey Menu, 1-12
 LOG, 4-2
 Low battery, 1-5, 2-13

M

MAF Meter Test, 5-10
 Magnetic Sensor Test, 5-26
 Main Display, 1-7
 Maintenance, 7-2
 Making Connections, 3-4
 Manifold Absolute Pressure Compared with Throttle

- Position Sensor, 6-15
- Manifold Absolute Pressure Test, 6-15
- Manual Range, 2-9
- Markers, 3-22
- Master reset, 4-7
- Master Reset Configuration, 4-7
- Math Function Pop-Up Menu, 4-20
- Math Softkey Menu, 4-20
- Math Source1/Source2/Destin Pop-Up Menus, 4-21
- MAX PEAK, 3-21
- MC Solenoid Test, 5-22, 5-39
- MEAN, 3-21
- Measurement Connections, 1-17
- Measuring Components, 4-8
- Memory Clear Softkey Menu, 4-8
- Menus
 - Auto Setup Pop-Up, 4-7
 - Channel Softkey, 3-16, 4-17
 - Component Measurement Pop-Up, 4-8
 - Cursor Data Softkey, 3-21
 - Cursor Function Pop-Up, 3-21
 - Cursor Marker Pop-Up, 3-23
 - Generator Pop-Up, 4-9
 - Grid Pop-Up, 1-15
 - Initial Setup Pop-Up, 4-5
 - LCD Softkey, 1-12
 - Math Function Pop-Up, 4-20
 - Math Softkey, 4-20
 - Math Source1/Source2/Destin Pop-Up, 4-21
 - Memory Clear Softkey, 4-8
 - Meter Display Modes Pop-Up, 2-11

Menus(cont)

- Meter Record Display Modes Pop-Up, 4-14
- Meter Record Zero Pop-Up, 4-15
- Meter Softkey, 2-4
- Picture Pop-Up, 1-14
- Printer Setup Pop-Up, 4-4
- Print Format Pop-Up, 4-3
- Scope Softkey, 3-5
- Setup Delete Pop-Up, 1-32
- Setup Recall Pop-Up, 1-31
- Setup Save Pop-Up, 1-31
- Setup Softkey, 1-30
- Special Functions Softkey, 4-2
- Trigger Delay Pop-Up, 3-11
- Trigger Softkey, 3-10
- Waveform Copy From/To Pop-Up, 4-19
- Waveform ON/OFF Pop-Up, 4-18
- Waveform Softkey, 4-18
- Menu Trees (Appendix 8E), 8-33
- Message Bars, 1-8
- Meter Connections (figure), 2-3
- Meter Display Modes Pop-Up Menu, 2-10 to 2-11
- Meter Inputs, 1-17
- Meter Mode, 1-19
- Meter Mode Connections, 2-3
- Meter Mode (figure), 2-2
- Meter Record, 2-13
- Meter Record Display Modes Pop-Up Menu, 4-13 to 4-14

Meter Record Scaling, 4-13
 Meter Record Zero, 4-15
 Meter Record Zero Pop-Up Menu, 4-15
 Meter Softkey Menus, 2-4
 Meter Verification, 7-6
 Minimizing Signal Noise, 4-9
 MIN MAX on A, 3-16
 MIN PEAK, 3-21
 MULTIPLY, 4-21 to 4-22
 Multi-Position Bracket (figure), 1-3
 MV DC, 2-6

N

N-Cycle, 3-12
 Noise Test, 5-36
 Nonvolatile memories, 4-18

O

Only AMPL, 4-5
 Only TIME, 4-5
 Operating Configuration, 1-29
 Optional Accessories (North America) (table), 8-18
 Overload Indications, 2-15
 Oxygen Sensor \leftrightarrow Fuel Injector or MC Solenoid,
 5-39
 Oxygen Sensors, 5-22
 Oxygen Sensor Test, 5-22, 5-39

P

Parts and Accessories (Appendix 8B), 8-13
 Peak and Hold Injectors, 5-19
 PEAK/PEAK, 3-21
 Percentage, 4-10, 4-14
 change, 2-12
 duty cycle, 2-11
 Performance Test, 7-4
 Performance Test Setup (figure), 7-5
 Performing a Master Reset, 4-7
 PHASE, 3-22
 Picture, 1-13
 Picture Pop-Up Menu (figure), 1-14
 Piezo Crystal Test, 5-16
 Pop-up menus, 1-7
 Positioning the Waveform on the Display, 3-15
 Potentiometer Tests, 5-10
 Power Connections (figure), 1-4
 Powering Scopemeter, 1-4
 Pressure Measurement, 6-11
 Printer Setup, 4-3
 Printer Setup Pop-Up Menu, 4-4
 Print Format, 4-2
 Print Format Pop-Up Menu, 4-2 to 4-3
 Printing, 4-2
 Printing from a PC, 4-4
 Probe (10:1), 7-8 to 7-9
 Probe Calibration, 7-7
 Probe Selection, 7-7
 PV500, 6-11

Q

QUADRANT Grid, 1-16
Quick Meter Checks, 4-24

R

Reading the Display, 1-6
RECALL, 1-31
Recall Setup, 1-31
Recall waveform, 3-17, 4-18
Recurrent, 3-5
Reference Impedances, 4-13
Relative Reference, 2-12, 4-10
Reluctor Test, 5-26
Replacing the Batteries, 7-2
Resistance, 2-8
Reverse Display, 1-12
RFI Test, 5-36
Right Display (Pop-Up Menu), 1-7
RISE TIME, 3-22
RMS, 3-21
Roll Mode, 3-7
RPM80, 6-2
RS-232-C Serial Interface Connection, 1-18

S

Safety, iv
Saturated Switch Drivers, 5-19
SAVE, 1-31
SCALE, 4-22
Scaling, 2-12, 4-12
Scaling Formula, 4-12

Scope Inputs, 1-17
Scope Mode, 1-22
Scope Mode Connections (figure), 3-4
Scope Mode (figure), 3-2
Scope Record Mode (MIN/MAX On A), 3-19
Scope Softkey Menu, 3-5
Scope Verification, 7-6
SCREEN, 4-2
Scrolling, 3-22
Secondary Ignition Testing (Capacitive Pickup), 6-2
Selecting the Trigger, 3-7
Service, 7-3
Service Centers, 8-21
Service Manual, 8-13
Setup Delete Pop-Up Menu, 1-32
Setup Memory, 1-29
Setup Recall Pop-Up Menu, 1-31
Setup Save Pop-Up Menu, 1-31
Setup Softkey Menu, 1-30
Signal Generator, 4-9
Signal Generator Output, 1-18
Single, 3-5
Slope, 3-10
SMOOTH (average readings), 2-12
Softkeys, 1-10
Softkeys and Pop-Up Menus, 1-8
Source1, 4-21
Source2, 4-21
Special Function Softkey Menu, 4-2
Specifications (Appendix 8A), 8-3
Standard Kit, 8-13 to 8-15

Start Print, 4-4
 Startup Configuration, 4-4
 Storing and Retrieving Waveforms, 4-18
 SUBTRACT, 4-21
 Suppression Diode Test, 5-5

T

Temperature Measurement, 6-5
 Temporary Memories, 4-18
 Terminology, 3-4
 Terminology (Appendix 8D), 8-25
 Throttle Body Injectors, 5-19
 Throttle Position Sensor Test, 5-10
 Tilt Stand/Bracket, 1-3
 TIME and AMPL, 4-5
 Time Base, 2-9 to 2-10, 3-13 to 3-14
 Time Delay, 3-12
 Top Display, 1-6
 Touch Hold, 2-13
 TPS Test, 6-15
 Trace Disp., 2-11
 Trace Display in Meter Mode, 2-10
 Transmission Pressure Test, 6-11
 TRIGGER at 50%, 3-12
 Trigger Basics, 3-7
 Trigger Delay, 3-11
 Trigger Delay Pop-Up Menu, 3-11
 Trigger Level, 3-11
 Trigger Slope, 3-11
 Trigger Softkey Menus, 3-10
 Trigger Source, 3-10

TRIG to -1-, 3-21
 Types of Waveforms, 3-2

U

Undo, 1-29
 Unpacking, iv
 Useful Techniques, 4-24
 Use of Terminology, iii
 User Maintenance, 7-1
 Using Your Scopemeter Safely, vi

V

Vacuum Measurement, 6-11
 Variable Position (Potentiometer) Sensors, 5-10
 Variable Reluctance Sensors (Magnetic), 5-26
 Variable Reluctance Sensor Test, 5-26
 V DC, 2-6
 Vehicle Height Sensor Test, 5-10
 Vehicle Speed Sensor, 5-26
 Voltage vs. Time, 1-22
 VOLT at -1-, 3-21
 Volt Math, 2-12, 4-13
 Vrms AC, 2-5

W

WARNING Statements, iv
 Warranty and Service Centers (Appendix 8C), 8-19
 WAVEFORM, 4-2
 Waveform Acquisition, 3-5
 Waveform Capture, 3-6
 Waveform Copy From/To Pop-Up Menus, 4-19

97/AUTO

Users Manual

Waveform Math, 4-20

Waveform ON/OFF Pop-Up Menu, 4-18

Waveform Quick Storage, 3-19

Waveform Softkey Menu, 4-18

Waveform Types (figure), 3-3

Wheel Speed Sensor, 5-26

Z

Zero, 2-12

Zero reference, 4-15

Zoom, 1-17

SCOPEMETER SETUPS

Whenever you press keys to configure ScopeMeter for a test, you are creating a setup. You can then store this entire key sequence in memory. Later, you can recall that memory and automatically set up ScopeMeter for the same test.

ScopeMeter lets you store 10 setups. For example, you might want to store a "Throttle Position Sensor (TPS) Test" in Setup 1, a "Fuel Injector Test" in Setup 2, and so on. The following form provides a place to keep track of your setups. (For convenient reference, make copies of this page.)

Setup 1	_____
Setup 2	_____
Setup 3	_____
Setup 4	_____
Setup 5	_____
Setup 6	_____
Setup 7	_____
Setup 8	_____
Setup 9	_____
Setup 10	_____